

## 1-Line , Uni-directional , Transient Voltage Suppressor

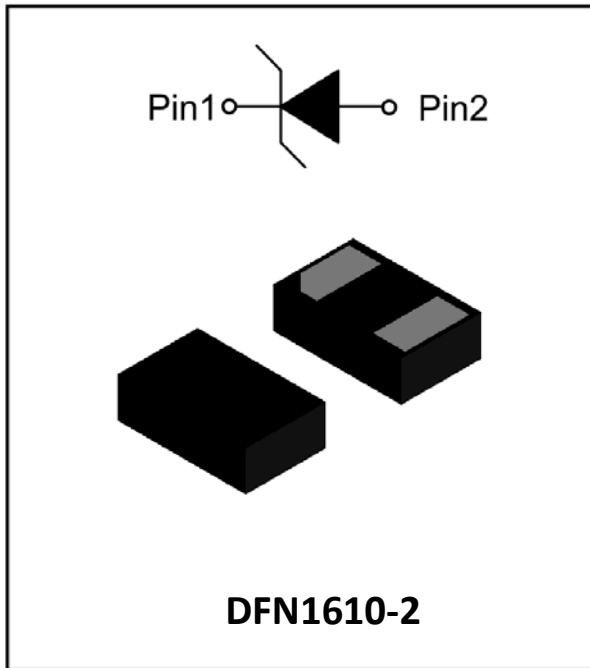

### Features

- Ultra small package
- Stand-off voltage: 18V
- Transient protection for each line according to
  - IEC61000-4-2(ESD):  $\pm 30\text{kV}$  (contact)
  - IEC61000-4-4 (EFT): 80A (5/50ns)
  - IEC61000-4-5(surge):40A (8/20 $\mu\text{s}$ )
- Low clamping voltage
- RoHS Compliant

### Applications

- Power supply protection
- Power management
- Battery Contacts

### Mechanical Characteristics

- Package: DFN1610-2L
- Case Material: "Green" Molding Compound.
- Moisture Sensitivity: Level 3 per J-STD-020
- Marking Information: See Below



### ■Definitions of electrical characteristics

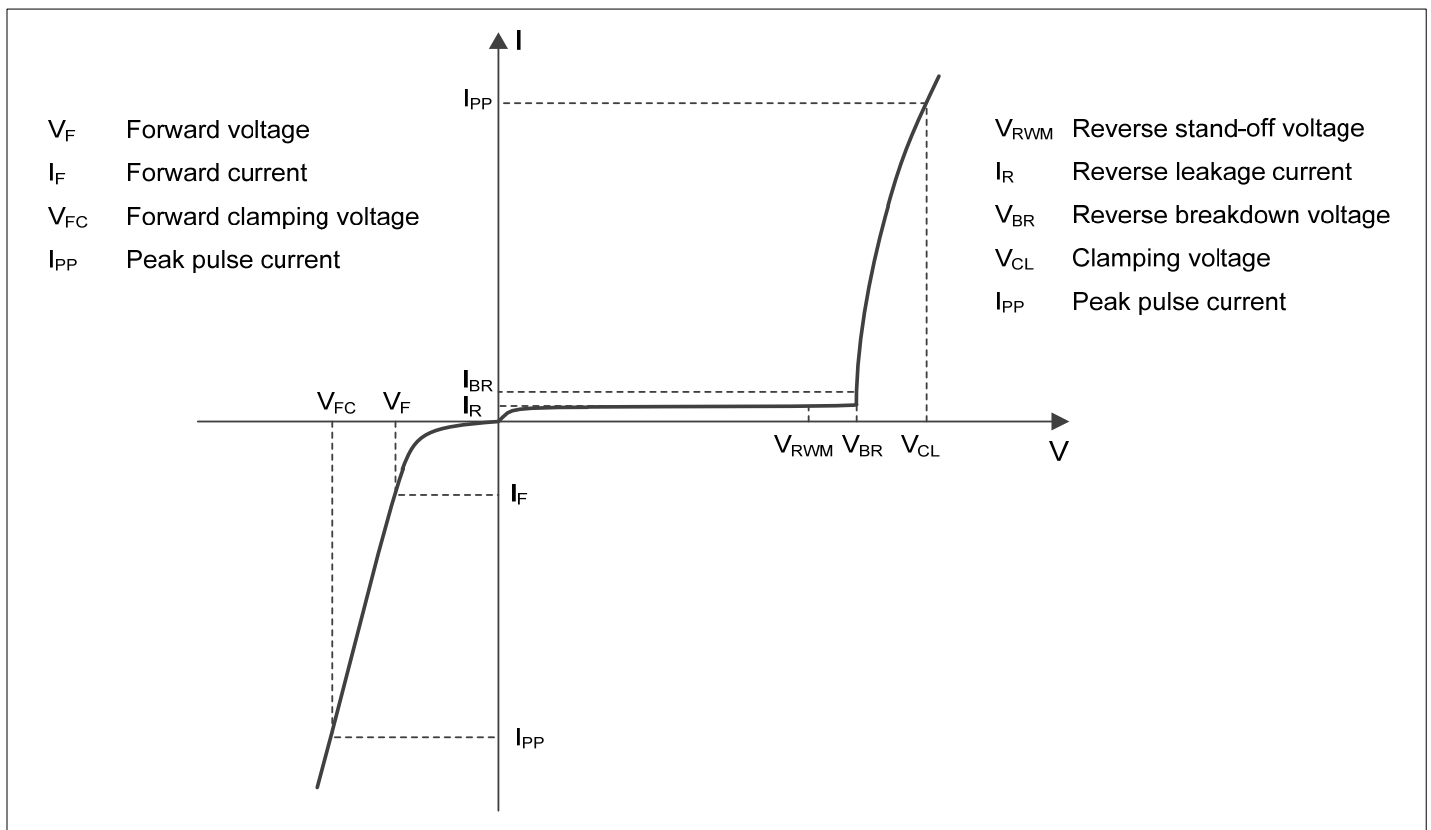



# ESD24VP6A

## ■Absolute Maximum Ratings (Ta=25°C unless otherwise specified)

PARAMETER	SYMBOL	LIMITS	UNIT
Peak pulse power ( $t_p = 8/20\mu s$ )	$P_{pk}$	1720	W
Peak pulse current ( $t_p = 8/20\mu s$ )	$I_{PP}$	40	A
ESD according to IEC61000-4-2 air discharge	$V_{ESD}$	$\pm 30$	kV
ESD according to IEC61000-4-2 contact discharge		$\pm 30$	
Operating Temperature Range	$T_J$	-55~125	°C
Storage Temperature Range	$T_{STG}$	-55~150	°C

## ■Electrical Characteristics (Ta=25°C Unless otherwise specified)

PARAMETER	Symbol	UNIT	Conditions	Min	Typ	Max
Reverse maximum working voltage	$V_{RWM}$	V				24
Reverse leakage current	$I_R$	$\mu A$	$V_{RWM} = 24V$			1
Reverse breakdown voltage	$V_{BR}$	V	$I_{BR} = 1mA$	24.7		29
Forward voltage	$V_F$	V	$I_F = 20mA$	0.45		1.25
Clamping voltage <sup>1)</sup>	$V_{CL}$	V	$I_{PP} = 40A, t_p = 8/20\mu s$			43
Junction capacitance	$C_J$	pF	$V_R = 0V, f = 1MHz$		210	250

Notes:

(1). Non-repetitive current pulse, according to IEC61000-4-5. (8/20 $\mu s$  current waveform).

## ■Ordering Information (Example)

PREFERRED P/N	PACKING CODE	UNIT WEIGHT(mg)	MINIMUM PACKAGE(pcs)	INNER BOX QUANTITY(pcs)	OUTER CARTON QUANTITY(pcs)	DELIVERY MODE
ESD24VP6A	F1	Approximate 270	3000	30000	120000	7" reel



# ESD24VP6A

## ■ Typical Performance Characteristics ( $T_A=25^\circ\text{C}$ unless otherwise Specified)

Fig.1 8/20 $\mu\text{s}$  waveform per IEC61000-4-5

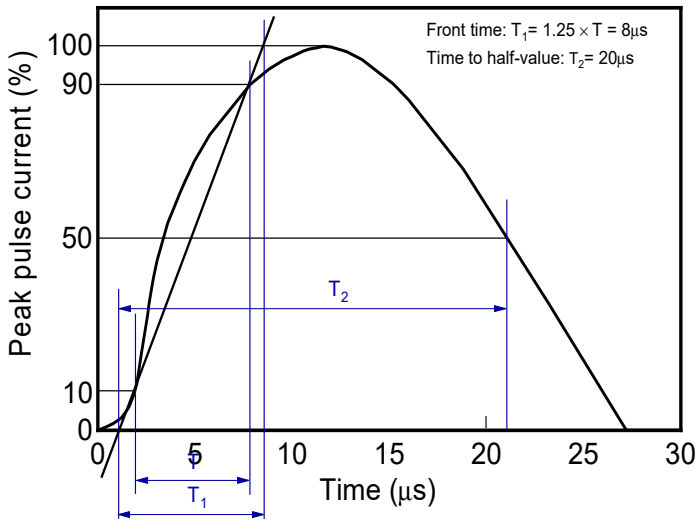

Fig.2 Contact discharge current waveform per IEC61000-4-2

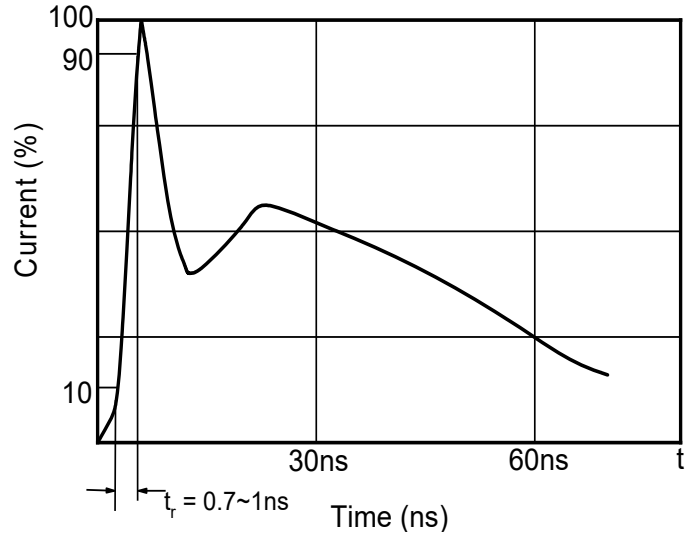

Fig.3 Clamping voltage vs. Peak pulse current

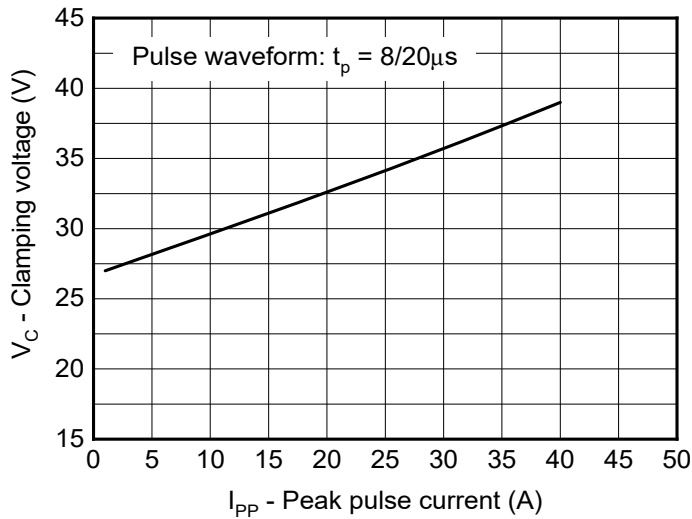

Fig.4 Non-repetitive peak pulse power vs. Pulse time

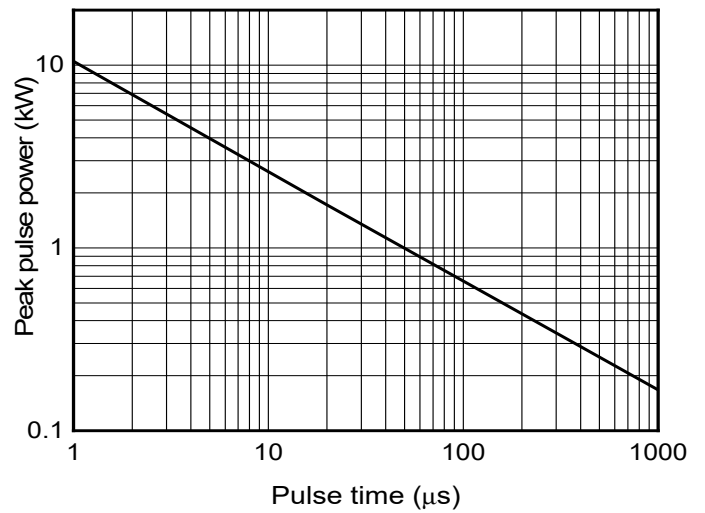
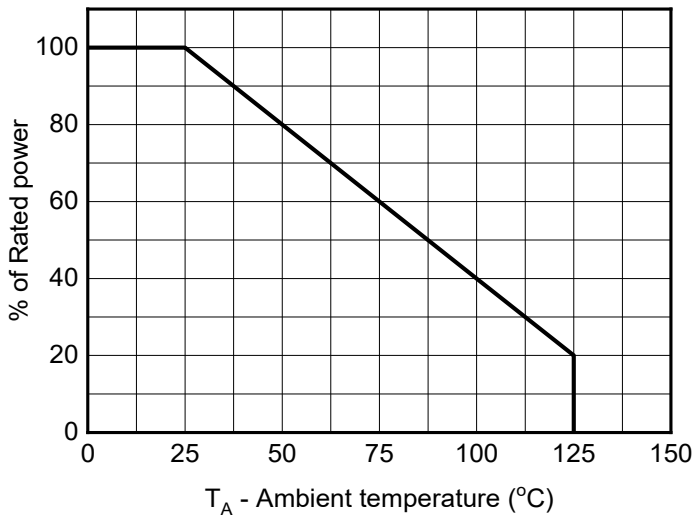

Fig.4 Power derating vs. Ambient temperature





# ESD24VP6A

## ■ Outline Dimensions

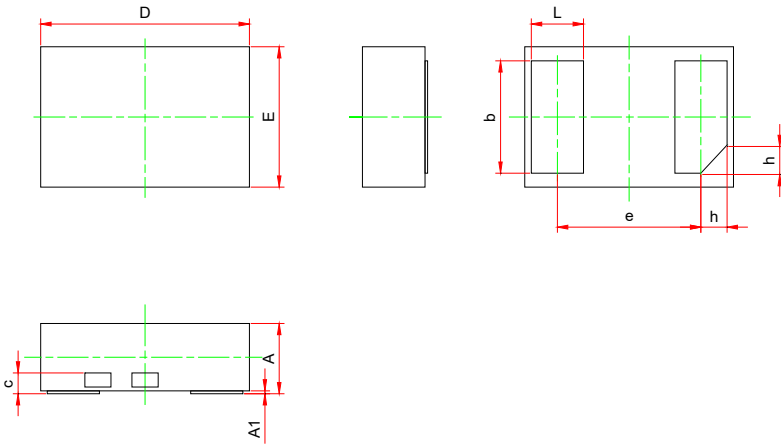

SYMBOL	MILLIMETER		
	MIN	NOM	MAX
A	0.45	0.50	0.55
A1	0.00	0.02	0.05
c	0.15 Ref.		
b	0.75	0.80	0.85
L	0.35	0.40	0.45
D	1.55	1.60	1.65
E	0.95	1.00	1.05
e	1.10 BSC		
h	0.20 Ref.		

## ■ Recommend land pattern (Unit:mm)

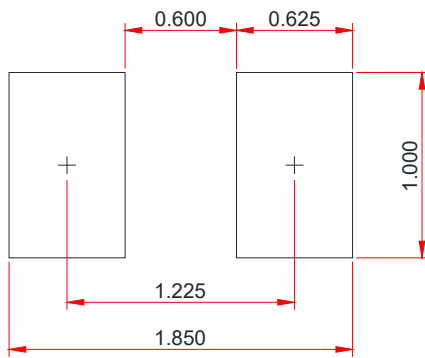

### Notes:

This recommended land pattern is for reference purposes only. Please consult your manufacturing group to ensure your PCB design guidelines are met.



## Disclaimer

The information presented in this document is for reference only. Yangzhou Yangjie Electronic Technology Co., Ltd. reserves the right to make changes without notice for the specification of the products displayed herein to improve reliability, function or design or otherwise.

The product listed herein is designed to be used with ordinary electronic equipment or devices, and not designed to be used with equipment or devices which require high level of reliability and the malfunction of which would directly endanger human life (such as medical instruments, transportation equipment, aerospace machinery, nuclear-reactor controllers, fuel controllers and other safety devices), Yangjie or anyone on its behalf, assumes no responsibility or liability for any damages resulting from such improper use of sale.

This publication supersedes & replaces all information previously supplied. For additional information, please visit our website [http:// www.21yangjie.com](http://www.21yangjie.com) , or consult your nearest Yangjie's sales office for further assistance.