



### Description

The YJ78LXX is a voltage regulator with output current at 0.1A and output voltage at 5V, 12V, 15V.

The device is designed to suit wide range of applications where good voltage regulation, current limiting, and thermal overload protection are essential to reliable long-term operations. With adequate heat sink attached, the regulator delivers output current to the maximum value of 100mA.

Packages offered include SOT-89-3L.

### Features and Benefits

- Fixed output level at 5/12/15V with accuracy up to ±2% (at 5V)
- Output current up to 100mA with foldback style current limiting
- Good immunization from input noise with PSRR at > 62dB typical
- Wide operating temperature range at T<sub>J</sub> = -40 ~ 125°C
- Built-in thermal shut-down to ensure reliable operation
- No external components needed for proper operation
- Lead-free package assembled with 'green' molding compound

### Applications

- Operating voltage supply to MCU, peripheral components used in CE appliances, industrial computing peripherals, network & communication systems
- Commonly adopted in e-Bike, 2/4-wheel scooters, toys, power adapters for computer peripherals / set-top boxes / routers, white & brown goods, industrial machineries, test equipment

### Pin Assignment

SOT-89-3L

(Top View)

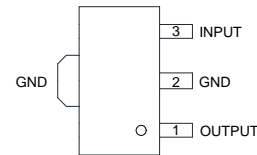

### Ordering Information

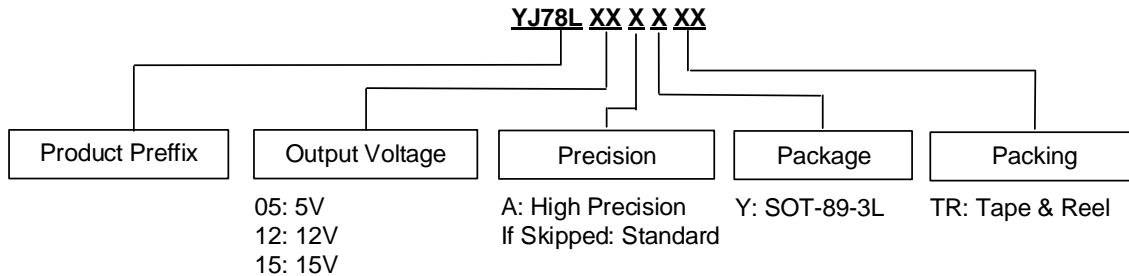

Product Name	Package	Marking	MSL	T <sub>J</sub> (°C)	Media	Quantity (pcs)
YJ78L05Y	SOT-89-3L	RLE	3	-40 ~ 125	7" T&R	1,000
YJ78L05AY		RLA				
YJ78L12Y		RLF				
YJ78L15Y		RLG				

### Marking Information

SOT-89-3L

(Top View)

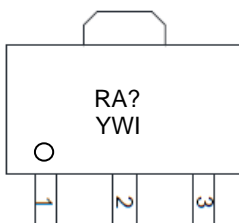

First Line: Marking (see *Ordering Information*)

Second Line: Date Code

- Y: Year of Molding
- W: Work-week of Molding
- I: Internal Code

**Typical Application Circuit**

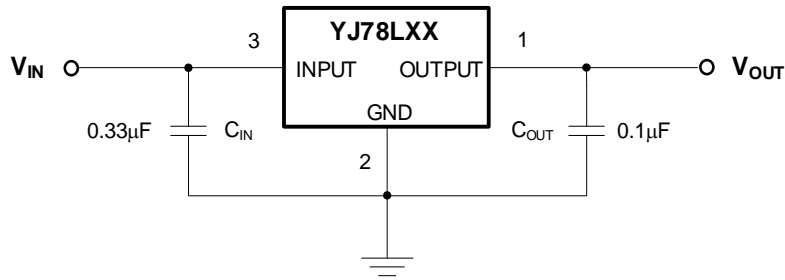

**Fig. 1: Application Circuit**

**Diagram of Functional Blocks**

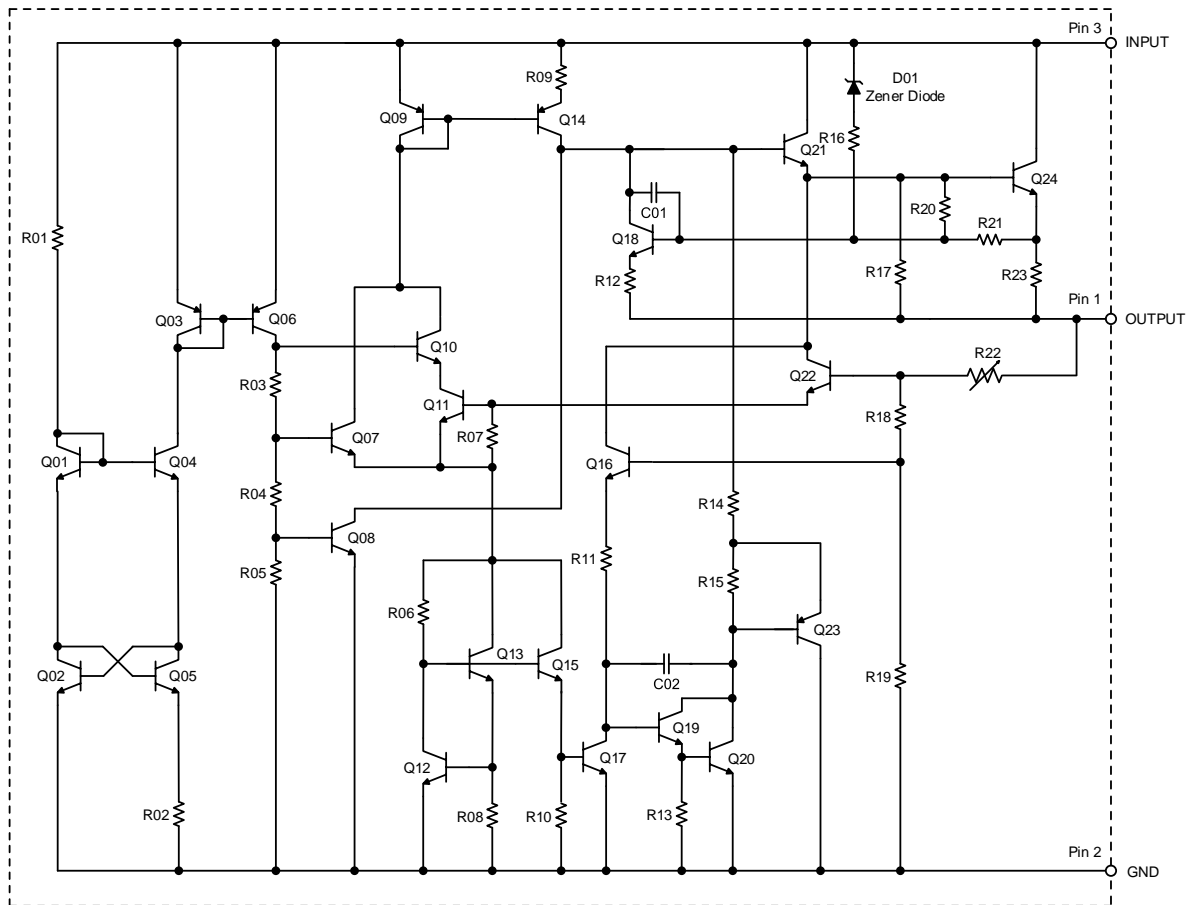

**Fig. 2: Diagram of Internal Functional Blocks**

**Absolute Maximum Ratings** <sup>\*1</sup> (All measurements were made at T<sub>A</sub> = 25°C unless stated otherwise)

Symbol	Parameter	Values	Unit
V <sub>IN</sub>	Input Voltage	36	V
T <sub>J</sub>	Operating Junction Temperature	150	°C
T <sub>LEAD</sub>	Lead Temperature (soldering, 10s)	260	°C
T <sub>STG</sub>	Storage Temperature Range	-65 ~ 150	°C
HBM	ESD (Human Body Model)	2	kV
MM	ESD (Machine Model)	200	V

Note 1: Stresses greater than those listed under "Absolute Maximum Ratings" may cause permanent damage to the device. While these are stress ratings only, functional operation of the device at these or any other conditions beyond those indicated under "Recommended Operating Conditions" are not implied. Exposure to "Absolute Maximum Ratings" for extended periods may affect device reliability.

**Recommended Operating Conditions** (All measurements were made at T<sub>A</sub> = 25°C unless stated otherwise)

Symbol	Parameter	Min.	Max.	Unit
V <sub>IN</sub>	Input Voltage	–	30	V
T <sub>J</sub>	Operating Junction Temperature Range	-40	125	°C

**Electrical Characteristics**

**YJ78L05:** (V<sub>IN</sub> = 10V, I<sub>OUT</sub> = 40mA, C<sub>IN</sub> = 0.33μF, C<sub>OUT</sub> = 0.1μF, T<sub>J</sub> = 25°C; *Italic & Bold* typefaces applies over -40°C ≤ T<sub>J</sub> ≤ 125°C unless otherwise specified)

Symbol	Parameter	Conditions	Min.	Typ.	Max.	Unit
V <sub>OUT</sub>	Output Voltage	-	4.8	5.0	5.2	V
		7V ≤ V <sub>IN</sub> ≤ 20V; 1mA ≤ I <sub>OUT</sub> ≤ 100mA P <sub>D</sub> ≤ 0.75W	<b>4.75</b>	–	<b>5.25</b>	
ΔV <sub>R-Load</sub>	Load Regulation	1mA ≤ I <sub>OUT</sub> ≤ 100mA	–	10	60	mV
ΔV <sub>R-Line</sub>	Line Regulation	7V ≤ V <sub>IN</sub> ≤ 20V	–	8	150	mV
I <sub>Q</sub>	Quiescent Current	-	–	3.0	5.5	mA
ΔI <sub>Q</sub>	Change to Quiescent Current	8V ≤ V <sub>IN</sub> ≤ 20V	–	–	<b>1.5</b>	mA
		1mA ≤ I <sub>OUT</sub> ≤ 40mA	–	–	<b>0.1</b>	
PSRR	Power Supply Rejection Ratio	Frequency = 120Hz; 8V ≤ V <sub>IN</sub> ≤ 18V	47	62	–	dB
V <sub>DROP</sub>	Drop-out Voltage	I <sub>OUT</sub> = 40mA	–	1.7	2.0	V
		I <sub>OUT</sub> = 100mA	–	1.8	2.3	
V <sub>NOISE</sub>	Noise over Output Voltage	10Hz ≤ Frequency ≤ 100kHz <sup>*2</sup>	–	40	–	μV
ΔV <sub>OUT</sub> /ΔT (ΔV <sub>OUT</sub> /V <sub>OUT</sub> )/ΔT	Temperature Coefficient of Output Voltage	I <sub>OUT</sub> = 5mA	–	0.42	–	mV/°C
			–	84	–	ppm/°C

Note 2: For the purpose of minimizing the high-frequency noise on the application circuit, load capacitance with value of 0.01μF at the very least is recommended.

**Electrical Characteristics** (Continued)**YJ78L05A:** ( $V_{IN} = 10V$ ,  $I_{OUT} = 40mA$ ,  $C_{IN} = 0.33\mu F$ ,  $C_{OUT} = 0.1\mu F$ ,  $T_J = 25^\circ C$ ; *Italic & Bold* typefaces applies over  $-40^\circ C \leq T_J \leq 125^\circ C$  unless otherwise specified)

Symbol	Parameter	Conditions	Min.	Typ.	Max.	Unit
$V_{OUT}$	Output Voltage	-	4.9	5.0	5.1	V
$\Delta V_{R-Load}$	Load Regulation	$1mA \leq I_{OUT} \leq 100mA$	-	10	60	mV
$\Delta V_{R-Line}$	Line Regulation	$7V \leq V_{IN} \leq 20V$	-	8	150	mV
$I_Q$	Quiescent Current	-	-	3.0	5.5	mA
$\Delta I_Q$	Change to Quiescent Current	$8V \leq V_{IN} \leq 20V$	-	-	<b>1.5</b>	mA
		$1mA \leq I_{OUT} \leq 40mA$	-	-	<b>0.1</b>	
PSRR	Power Supply Rejection Ratio	Frequency = 120Hz; $8V \leq V_{IN} \leq 18V$	47	62	-	dB
$V_{DROP}$	Drop-out Voltage	$I_{OUT} = 40mA$	-	1.7	-	V
		$I_{OUT} = 100mA$	-	1.8	-	
$V_{NOISE}$	Noise over Output Voltage	$10Hz \leq \text{Frequency} \leq 100kHz$ *2	-	40	-	$\mu V$
$\Delta V_{OUT}/\Delta T$	Temperature Coefficient of Output Voltage	$I_{OUT} = 5mA$	-	0.42	-	mV/ $^\circ C$
$(\Delta V_{OUT}/V_{OUT})/\Delta T$			-	84	-	ppm/ $^\circ C$

Note 3: For the purpose of minimizing the high-frequency noise on the application circuit, load capacitance with value of  $0.01\mu F$  at the very least is recommended.**YJ78L12:** ( $V_{IN} = 19V$ ,  $I_{OUT} = 40mA$ ,  $C_{IN} = 0.33\mu F$ ,  $C_{OUT} = 0.1\mu F$ ,  $T_J = 25^\circ C$ ; *Italic & Bold* typefaces applies over  $-40^\circ C \leq T_J \leq 125^\circ C$  unless otherwise stated)

Symbol	Parameter	Conditions	Min.	Typ.	Max.	Unit
$V_{OUT}$	Output Voltage	-	11.5	12.0	12.5	V
		$14.5V \leq V_{IN} \leq 27.0V$ $1mA \leq I_{OUT} \leq 100mA$ ; $P_D \leq 0.75W$	<b>11.4</b>	-	<b>12.6</b>	
$\Delta V_{R-Load}$	Load Regulation	$1mA \leq I_{OUT} \leq 100mA$	-	20	100	mV
$\Delta V_{R-Line}$	Line Regulation	$14.5V \leq V_{IN} \leq 27V$	-	20	250	mV
$I_Q$	Quiescent Current	-	-	3.0	6.0	mA
$\Delta I_Q$	Change to Quiescent Current	$16V \leq V_{IN} \leq 27V$	-	-	<b>1.5</b>	mA
		$1mA \leq I_{OUT} \leq 40mA$	-	-	<b>0.1</b>	
PSRR	Power Supply Rejection Ratio	Frequency = 120Hz; $15V \leq V_{IN} \leq 25V$	37	42	-	dB
$V_{DROP}$	Drop-out Voltage	$I_{OUT} = 40mA$	-	1.7	-	V
		$I_{OUT} = 100mA$	-	1.8	-	
$V_{NOISE}$	Noise over Output Voltage	$10Hz \leq \text{Frequency} \leq 100kHz$ *3	-	80	-	$\mu V$
$\Delta V_{OUT}/\Delta T$	Temperature Coefficient of Output Voltage	$I_{OUT} = 5mA$	-	1	-	mV/ $^\circ C$
$(\Delta V_{OUT}/V_{OUT})/\Delta T$			-	84	-	ppm/ $^\circ C$

Note 4: For the purpose of minimizing the high-frequency noise on the application circuit, load capacitance with value of  $0.01\mu F$  at the very least is recommended.

**Electrical Characteristics** (Continued)

**YJ78L15:** ( $V_{IN} = 23V$ ,  $I_{OUT} = 40mA$ ,  $C_{IN} = 0.33\mu F$ ,  $C_{OUT} = 0.1\mu F$ ,  $T_J = 25^\circ C$ ; *Italic & Bold* typefaces applies over  $-40^\circ C \leq T_J \leq 125^\circ C$  unless otherwise stated)

Symbol	Parameter	Conditions	Min.	Typ.	Max.	Unit
$V_{OUT}$	Output Voltage	-	14.4	15.0	15.6	V
		$17.5V \leq V_{IN} \leq 30V$ ; $1mA \leq I_{OUT} \leq 100mA$ $P_D \leq 0.75W$	<b>14.25</b>	-	<b>15.75</b>	
$\Delta V_{R-Load}$	Load Regulation	$1mA \leq I_{OUT} \leq 100mA$	-	25	100	mV
$\Delta V_{R-Line}$	Line Regulation	$17.5V \leq V_{IN} \leq 30.0V$	-	25	250	mV
$I_Q$	Quiescent Current	-	-	3.0	6.0	mA
$\Delta I_Q$	Change to Quiescent Current	$20V \leq V_{IN} \leq 30V$	-	-	<b>1.5</b>	mA
		$1mA \leq I_{OUT} \leq 40mA$	-	-	<b>0.1</b>	
PSRR	Power Supply Rejection Ratio	Frequency = 120Hz; $18.5V \leq V_{IN} \leq 28.5V$	34	39	-	dB
$V_{DROP}$	Drop-out Voltage	$I_{OUT} = 40mA$	-	1.7	-	V
		$I_{OUT} = 100mA$	-	1.8	-	
$V_{NOISE}$	Noise over Output Voltage	$10Hz \leq \text{Frequency} \leq 100kHz$ *4	-	90	-	$\mu V$
$\Delta V_{OUT}/\Delta T$	Temperature Coefficient of Output Voltage	$I_{OUT} = 5mA$	-	1.25	-	mV/ $^\circ C$
$(\Delta V_{OUT}/V_{OUT})/\Delta T$			-	84	-	ppm/ $^\circ C$

Note 5: For the purpose of minimizing the high-frequency noise on the application circuit, load capacitance with value of  $0.01\mu F$  at the very least is recommended.

**Thermal Properties**

Test Condition: Device mounted on FR-4 substrate, 2-layer PCB, 2oz copper, with minimum recommended cooling pad to dissipate heat

Symbol	Parameter	Package	Rating	Unit
$R_{\theta JC}$	Thermal Resistance (junction-to-case)	SOT-89-3L	28.3	$^\circ C/W$



### Typical Performance Characteristics

Graph 1: Output Voltage vs. Input Voltage

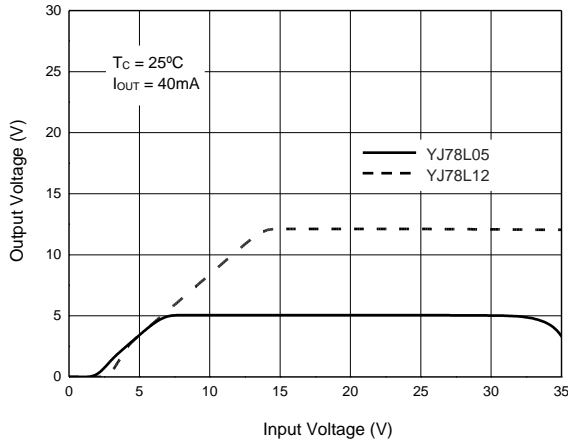

Graph 2: Output Voltage vs. Case Temperature

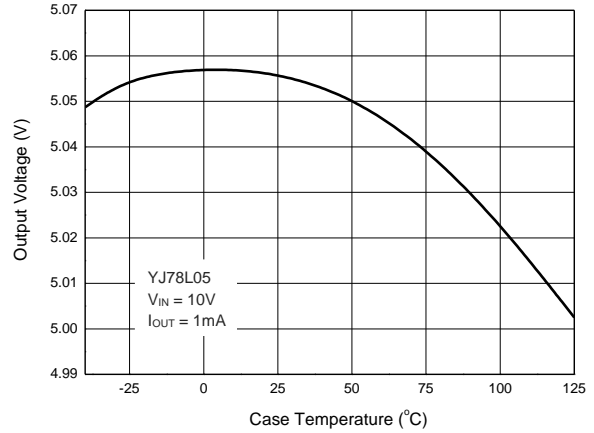

Graph 3: Over Temperature Protection

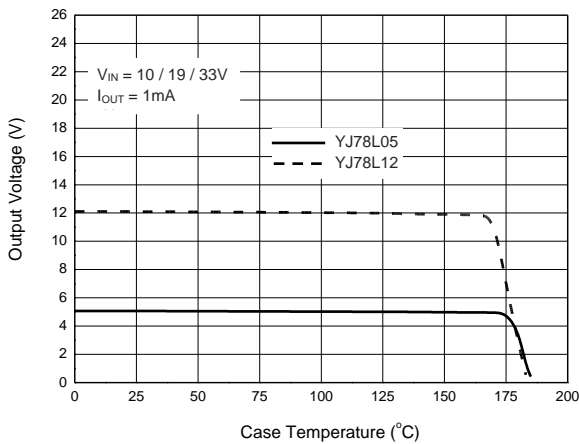

Graph 4: Drop-out Voltage vs. Case Temperature

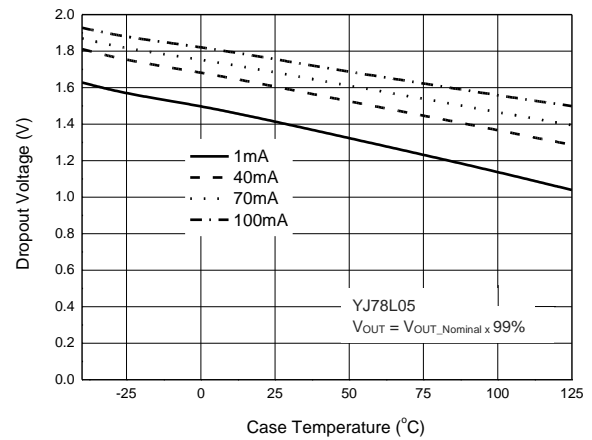

Graph 5: Output Voltage vs. Output Current

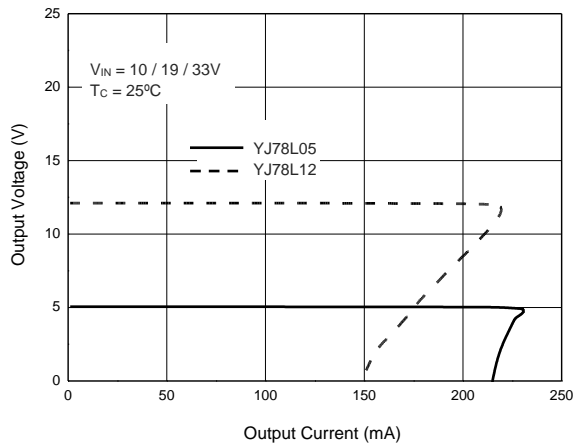

Graph 6: Quiescent Current vs. Case Temperature

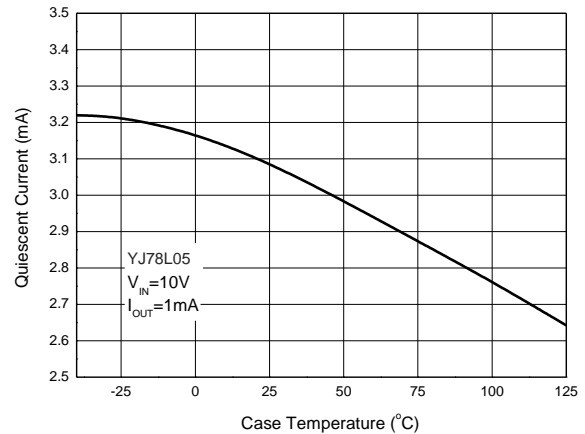



Typical Performance Characteristics (Continued)

Graph 7: Power Dissipation vs. Case Temperature

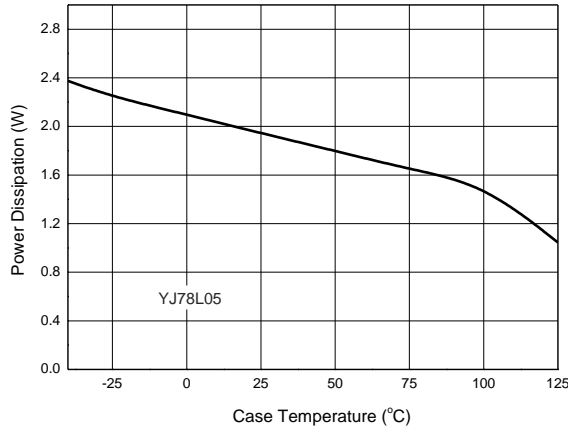

Graph 8: PSRR vs. Frequency

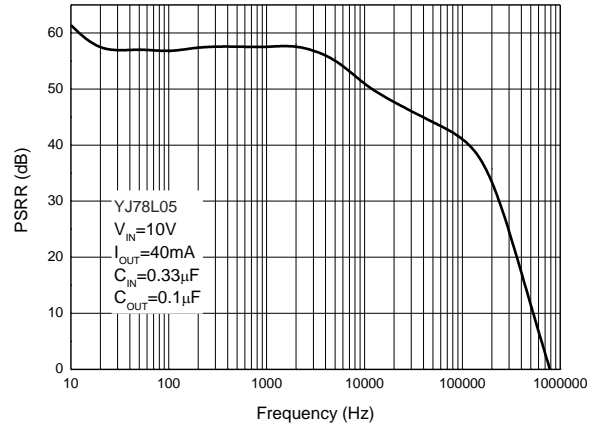

Graph 9: Line Transient

(Conditions:  $I_{OUT} = 40mA$ ,  $C_{IN} = 0.33\mu F$ ,  $C_{OUT} = 0.1\mu F$ )

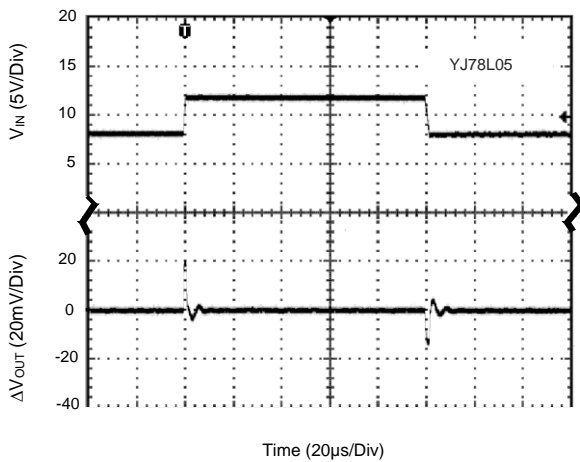

Graph 10: Load Transient

(Conditions:  $V_{IN} = 10V$ ,  $C_{IN} = 0.33\mu F$ ,  $C_{OUT} = 0.1\mu F$ )

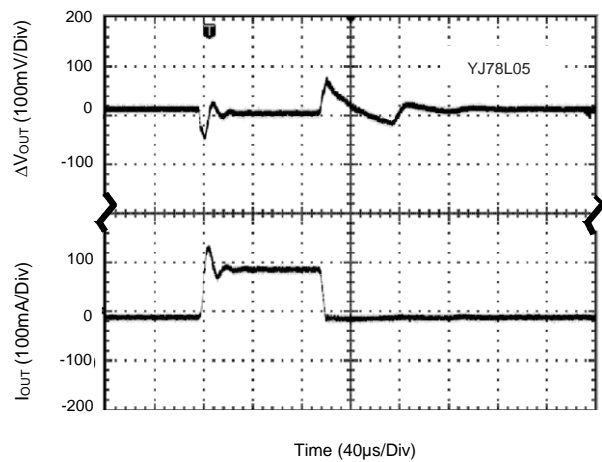

**Package Outline** (All measurements in mm & inch)

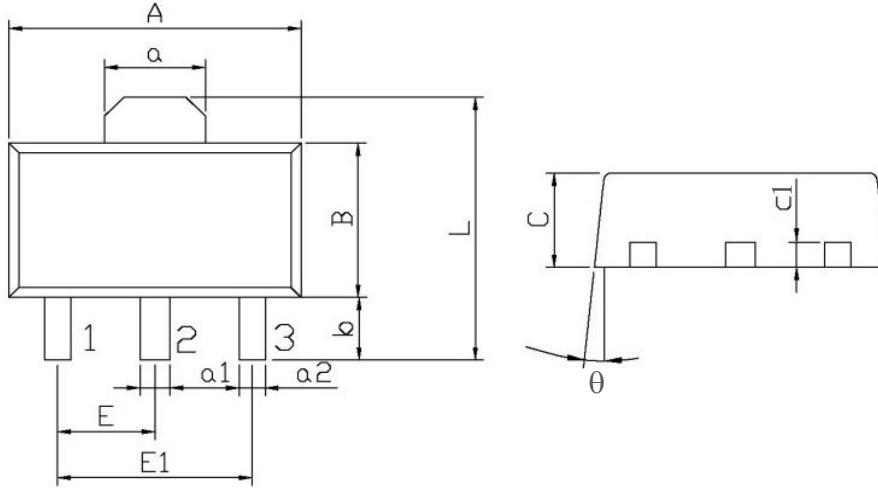
**Package Type: SOT-89-3L (J2)**

SOT-89-3L (J2)		
Dimension	Min.	Max.
A	4.40	4.70
a	1.45	1.65
a1	0.36	0.56
a2	0.30	0.50
B	2.35	2.65
b	0.80	1.20
C	1.40	1.70
c1	0.35	0.50
E	1.40	1.60
E1	2.80	3.20
L	3.878	4.478
θ	6°	
All measurements in "mm"		

**Suggested Pad Layout** (All measurements in mm & inch)

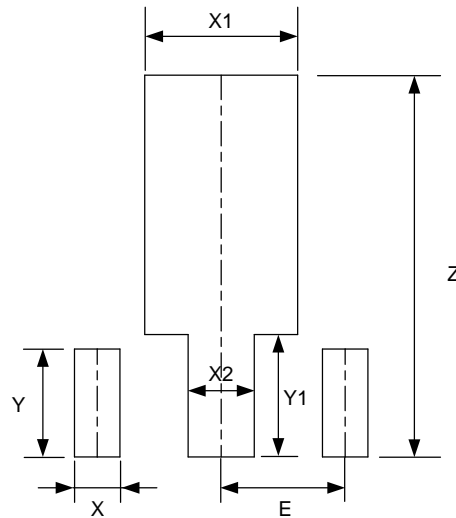
**Package Type: SOT-89-3L (J2)**

Dimension	Z (mm) / (inch)	X (mm) / (inch)	X1 (mm) / (inch)	X2 (mm) / (inch)	Y (mm) / (inch)	Y1 (mm) / (inch)	E (mm) / (inch)
Value	4.600 / 0.181	0.550 / 0.022	1.850 / 0.073	0.800 / 0.031	1.300 / 0.051	1.475 / 0.058	1.500 / 0.059





YJ78LXX

## 0.1A Linear Voltage Regulator

---

### Disclaimer

---

The information presented in this document are for reference only. Yangzhou Yangjie Electronic Technology Co., Ltd. (a.k.a. YJ) reserves the right to make changes without prior notice to the specification of the product displayed herein to improve reliability, function, design or otherwise.

The product listed herein is designed to be used with ordinary electronic equipment or devices. It is not designed, intended, or authorized for use as a critical component in equipment or devices (e.g. medical instruments, transportation equipment, aerospace machinery, nuclear-reactor controllers, fuel controllers and other safety devices) which require high level of reliability and the malfunction of which directly endangers human life. YJ or anyone on its behalf assumes no responsibility or liability for any damages resulting from such improper use of the product.

This publication supersedes & replaces all information previously supplied. For additional information, please visit our website <http://www.21yangjie.com>, or consult your nearest YJ Sales Offices for further assistance.