

P-Channel Enhancement Mode Field Effect Transistor

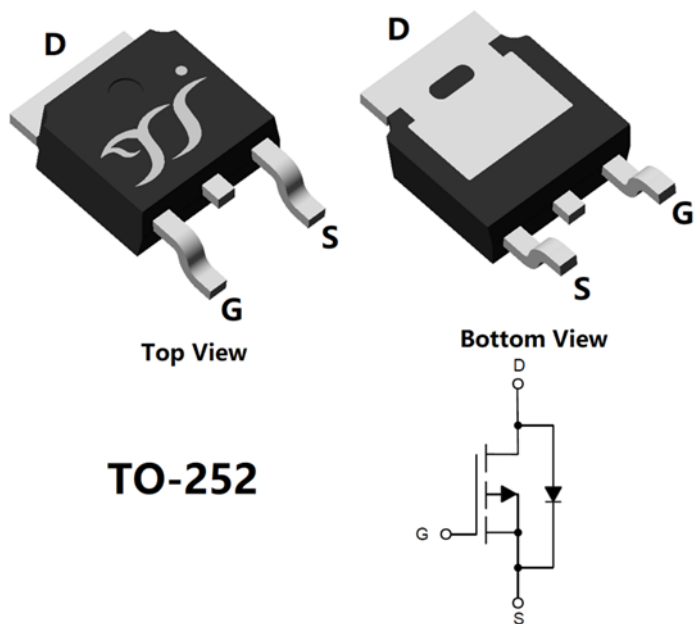

Product Summary

- V_{DS} -30 V
- I_D -40 A
- $R_{DS(ON)}$ (at $V_{GS}=-10V$) <14 m Ω
- $R_{DS(ON)}$ (at $V_{GS}=-4.5V$) <22 m Ω
- 100% EAS Tested
- 100% ∇V_{DS} Tested

General Description

- Trench Power LV MOSFET technology
- High density cell design for Low $R_{DS(ON)}$
- High Speed switching
- Moisture Sensitivity Level 1
- Epoxy Meets UL 94 V-0 Flammability Rating
- Halogen Free

Applications

- Battery protection
- Load switch
- Power management

■ Absolute Maximum Ratings ($T_A=25^\circ\text{C}$ unless otherwise noted)

Parameter		Symbol	Limit	Unit
Drain-source Voltage		V_{DS}	-30	V
Gate-source Voltage		V_{GS}	± 20	V
Drain Current	$T_A=25^\circ\text{C}$	I_D	-10	A
	$T_A=100^\circ\text{C}$		-6.3	
	$T_C=25^\circ\text{C}$		-40	
	$T_C=100^\circ\text{C}$		-25	
Pulsed Drain Current ^A		I_{DM}	-120	A
Avalanche energy ^B		EAS	49	mJ
Total Power Dissipation ^C	$T_A=25^\circ\text{C}$	P_D	2.5	W
	$T_A=100^\circ\text{C}$		1	
	$T_C=25^\circ\text{C}$		83	
	$T_C=100^\circ\text{C}$		33	
Junction and Storage Temperature Range		T_J, T_{STG}	-55~+150	$^\circ\text{C}$

■ Thermal resistance

Parameter		Symbol	Typ	Max	Units
Thermal Resistance Junction-to-Ambient ^D	Steady-State	$R_{\theta JA}$	40	50	$^\circ\text{C/W}$
Thermal Resistance Junction-to-Case	Steady-State	$R_{\theta JC}$	1.2	1.5	

■ Ordering Information (Example)

PREFERRED P/N	PACKING CODE	Marking	MINIMUM PACKAGE(pcs)	INNER BOX QUANTITY(pcs)	OUTER CARTON QUANTITY(pcs)	DELIVERY MODE
YJD40P03B	F1/F2	YJD40P03B	2500	/	25000	13" reel



YJD40P03B

■ Electrical Characteristics (T_J=25°C unless otherwise noted)

Parameter	Symbol	Conditions	Min	Typ	Max	Units
Static Parameter						
Drain-Source Breakdown Voltage	BV _{DSS}	V _{GS} = 0V, I _D =-250μA	-30	-	-	V
Zero Gate Voltage Drain Current	I _{DSS}	V _{DS} =-30V, V _{GS} =0V	-	-	-1	μA
		V _{DS} =-30V, V _{GS} =0V, T _J =150°C	-	-	-100	
Gate-Body Leakage Current	I _{GSS}	V _{GS} = ±20V, V _{DS} =0V	-	-	±100	nA
Gate Threshold Voltage	V _{GS(th)}	V _{DS} = V _{GS} , I _D =-250μA	-1	-1.5	-2.5	V
Static Drain-Source On-Resistance	R _{DS(on)}	V _{GS} =-10V, I _D =-20A	-	10.5	14	mΩ
		V _{GS} =-4.5V, I _D =-20A	-	16	22	
Diode Forward Voltage	V _{SD}	I _S =-20A, V _{GS} =0V	-	-0.9	-1.3	V
Gate resistance	R _G	f=1MHz	-	14	-	Ω
Maximum Body-Diode Continuous Current	I _S		-	-	-40	A
Dynamic Parameters						
Input Capacitance	C _{iss}	V _{DS} =-15V, V _{GS} =0V, f=1MHz	-	1220	-	pF
Output Capacitance	C _{oss}		-	170	-	
Reverse Transfer Capacitance	C _{rss}		-	160	-	
Switching Parameters						
Total Gate Charge	Q _g	V _{GS} =-10V, V _{DS} =-15V, I _D =-10A	-	24	-	nC
Gate-Source Charge	Q _{gs}		-	2	-	
Gate-Drain Charge	Q _{gd}		-	6	-	
Reverse Recovery Charge	Q _{rr}	I _F =-10A, di/dt=100A/us	-	11	-	nC
Reverse Recovery Time	t _{rr}		-	35	-	ns
Turn-on Delay Time	t _{D(on)}	V _{GS} =-10V, V _{DD} =-15V, I _D =-10A R _{GEN} =2.5Ω	-	11	-	ns
Turn-on Rise Time	t _r		-	4	-	
Turn-off Delay Time	t _{D(off)}		-	70	-	
Turn-off fall Time	t _f		-	50	-	

A. Repetitive rating; pulse width limited by max. junction temperature.

B. T_J=25°C, V_{DD}=-25V, V_G=-10V, R_G=25Ω, L=0.5mH, I_{AS}=-14A.

C. P_d is based on max. junction temperature, using junction-case and junction-ambient thermal resistance.

D. The value of R_{θJA} is measured with the device mounted on 1 in² FR-4 board with 2oz. Copper, in the still air environment with T_A =25°C. The maximum allowed junction temperature of 150°C. The value in any given application depends on the user's specific board design.



YJD40P03B

Typical Electrical and Thermal Characteristics Diagrams

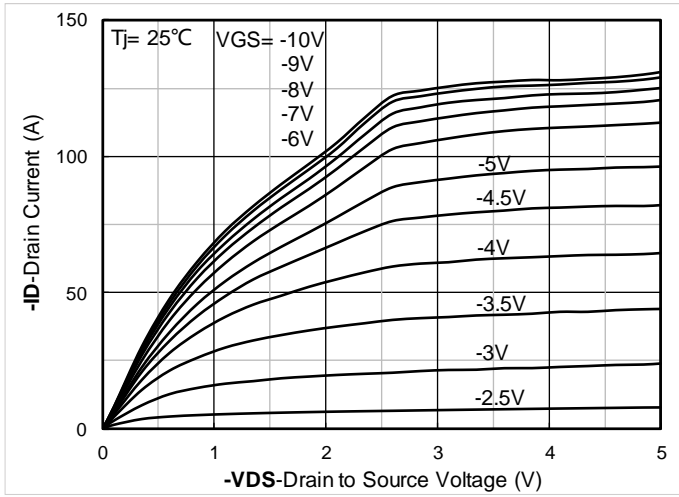

Figure 1. Output Characteristics

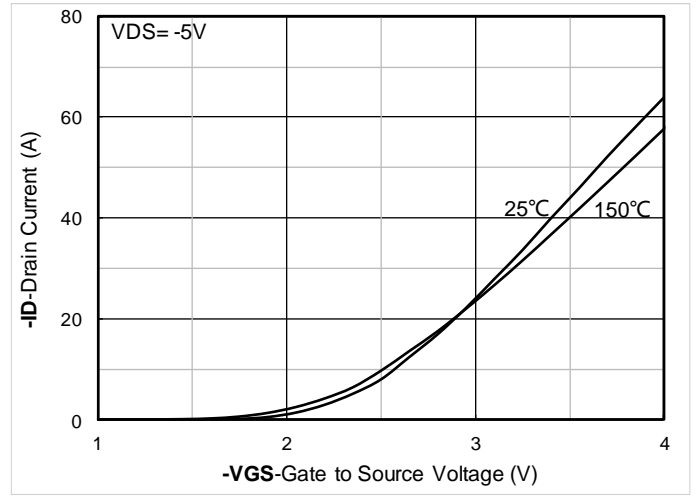

Figure 2. Transfer Characteristics

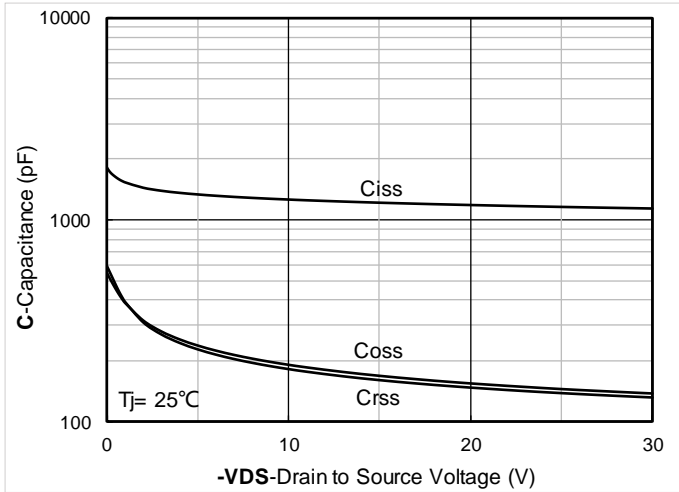

Figure 3. Capacitance Characteristics

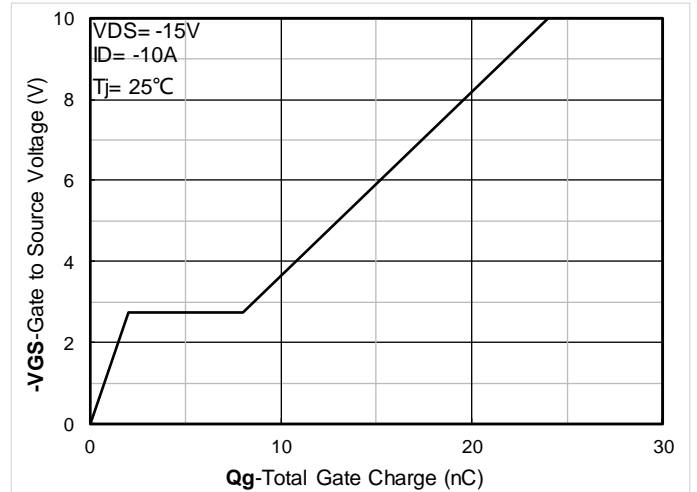

Figure 4. Gate Charge

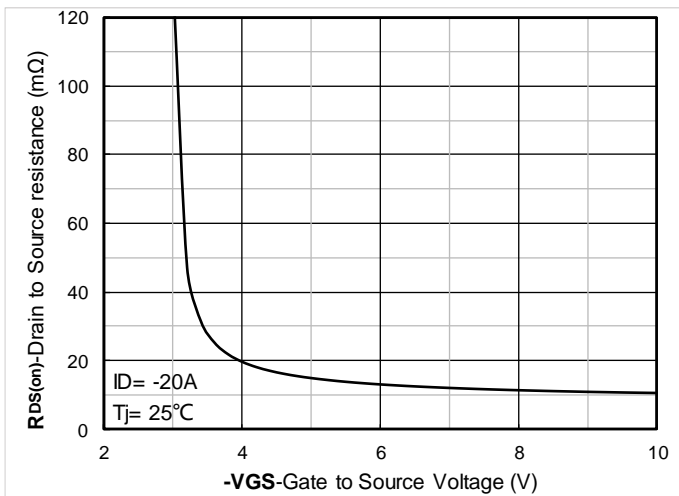

Figure 5. On-Resistance vs Gate to Source Voltage

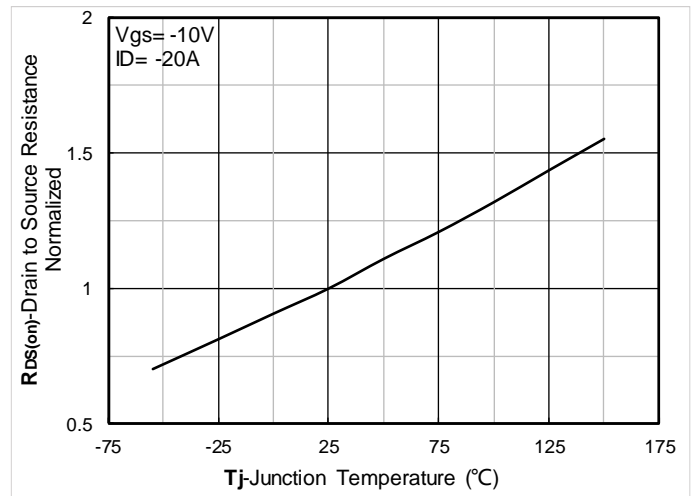

Figure 6. Normalized On-Resistance



YJD40P03B

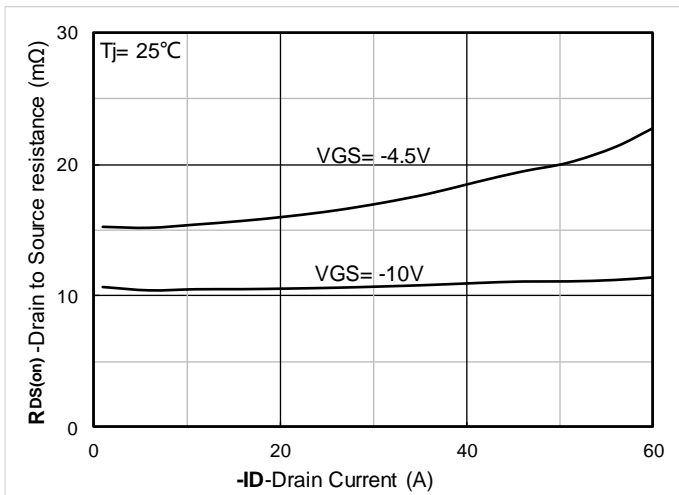

Figure 7. $R_{DS(on)}$ VS Drain Current

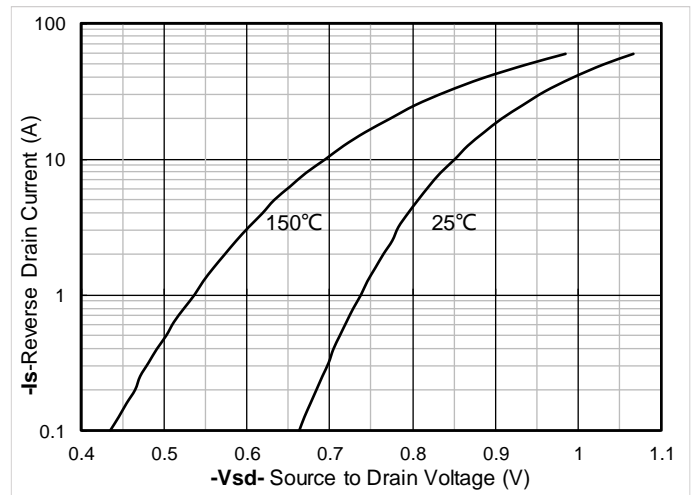

Figure 8. Forward characteristics of reverse diode

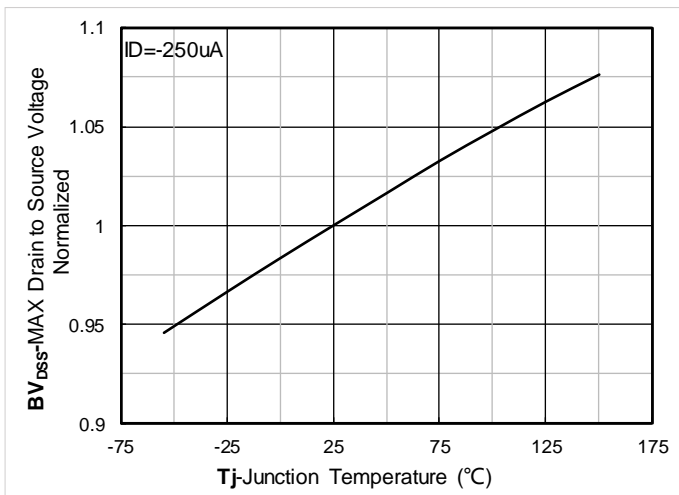

Figure 9. Normalized breakdown voltage

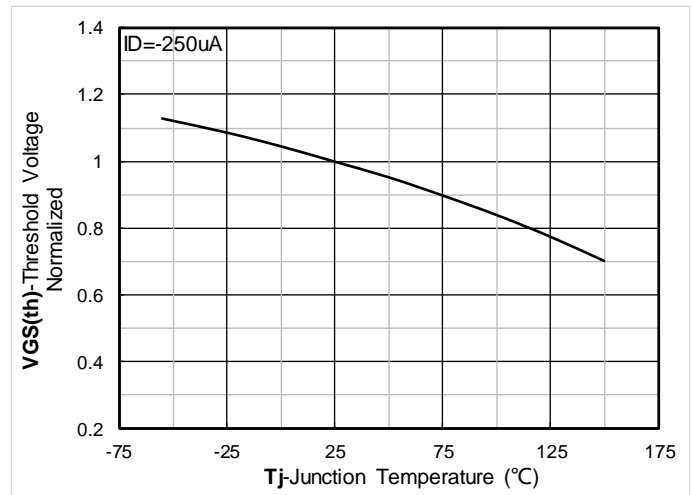

Figure 10. Normalized Threshold voltage

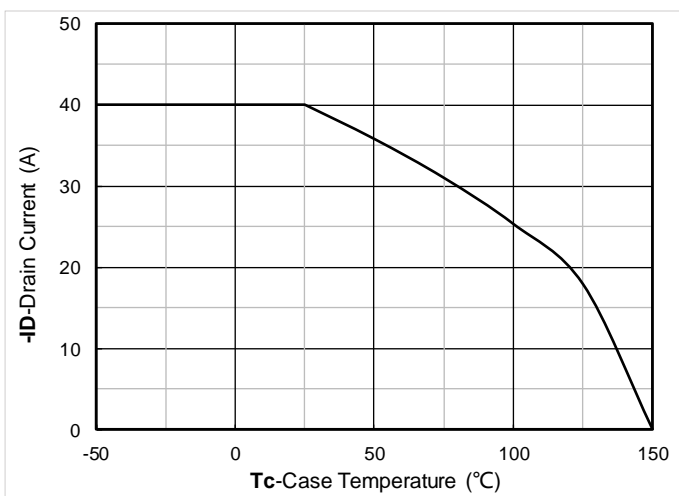

Figure 11. Current dissipation

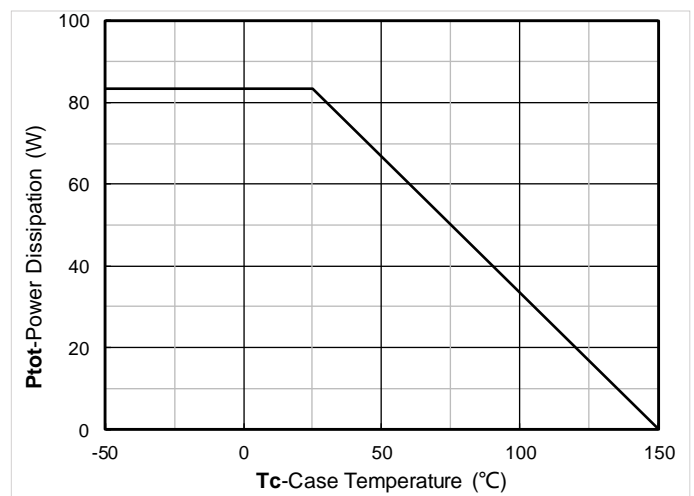

Figure 12. Power dissipation



YJD40P03B

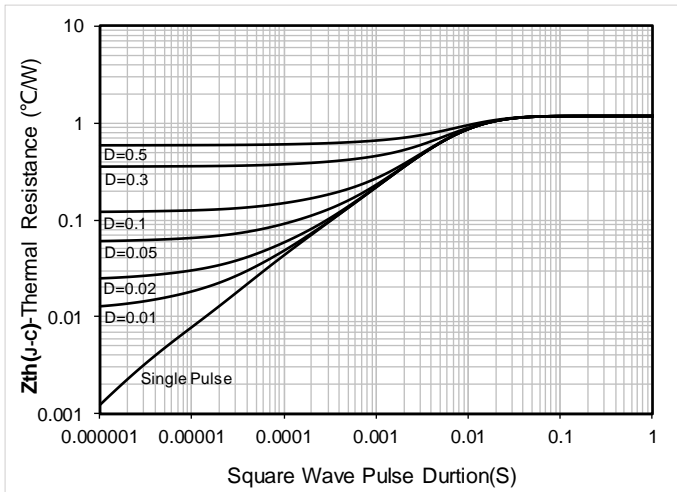

Figure 13. Maximum Transient Thermal Impedance

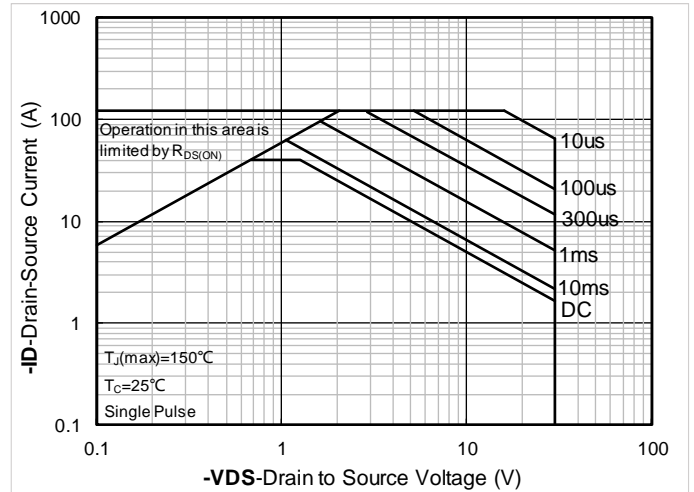
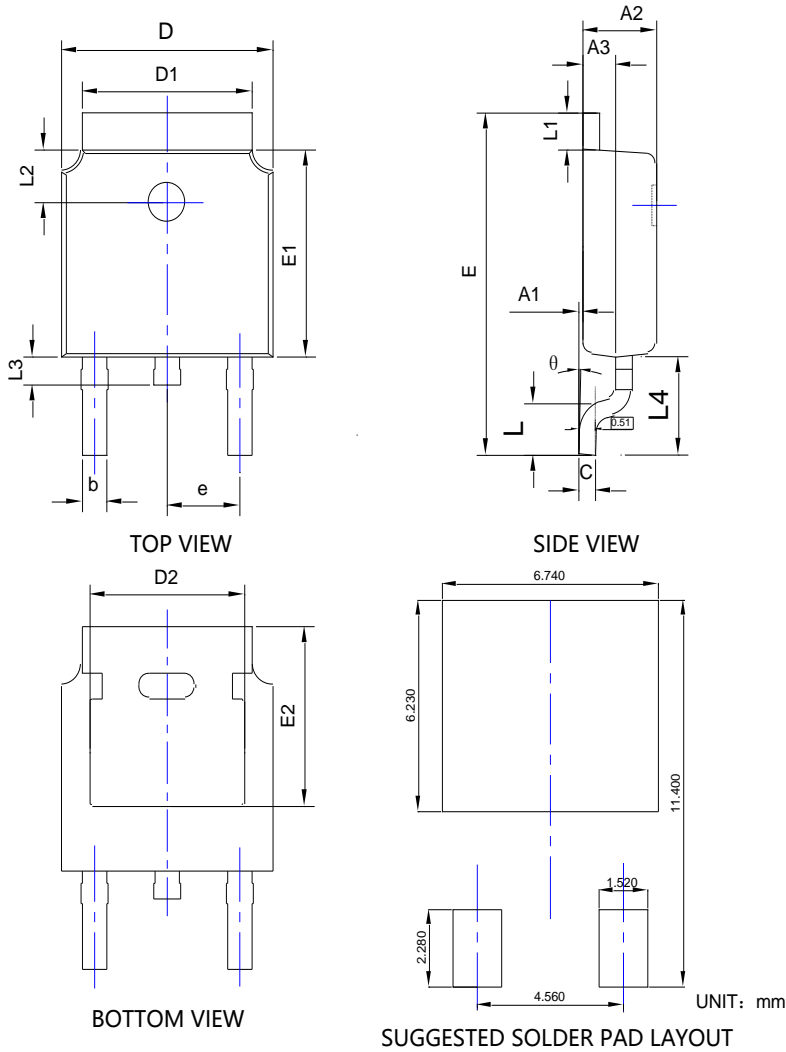

Figure 14. Safe Operation Area



YJD40P03B

TO-252-B Package information



SYMBOL	DIMENSIONS					
	INCHES			Millimeter		
	MIN.	NOM.	MAX.	MIN.	NOM.	MAX.
A1	0.000	---	0.008	0.000	---	0.200
A2	0.087	0.091	0.094	2.200	2.300	2.400
A3	0.035	0.039	0.043	0.900	1.000	1.100
b	0.026	0.030	0.034	0.660	0.760	0.860
c	0.018	0.020	0.023	0.460	0.520	0.580
D	0.256	0.260	0.264	6.500	6.600	6.700
D1	0.203	0.209	0.215	5.150	5.300	5.450
D2	0.181	0.189	0.195	4.600	4.800	4.950
E	0.390	0.398	0.406	9.900	10.100	10.300
E1	0.236	0.240	0.244	6.000	6.100	6.200
E2	0.203	0.209	0.215	5.150	5.300	5.450
e	0.090BSC			2.286BSC		
L	0.049	0.059	0.069	1.250	1.500	1.750
L1	0.035	---	0.050	0.900	---	1.270
L2	0.055	---	0.075	1.400	---	1.900
L3	0.024	0.031	0.039	0.600	0.800	1.000
L4	0.114REF			2.900REF		
θ	0°	---	10°	0°	---	10°

NOTE:
 1. PACKAGE BODY SIZES EXCLUDE MOLD FLASH AND GATE BURRS.
 2. TOLERANCE 0.1mm UNLESS OTHERWISE SPECIFIED.
 3. THE PAD LAYOUT IS FOR REFERENCE PURPOSES ONLY.



YJD40P03B

Disclaimer

The information presented in this document is for reference only. Yangzhou Yangjie Electronic Technology Co., Ltd. reserves the right to make changes without notice for the specification of the products displayed herein to improve reliability, function or design or otherwise.

The product listed herein is designed to be used with ordinary electronic equipment or devices, and not designed to be used with equipment or devices which require high level of reliability and the malfunction of which would directly endanger human life (such as medical instruments, transportation equipment, aerospace machinery, nuclear-reactor controllers, fuel controllers and other safety devices), Yangjie or anyone on its behalf, assumes no responsibility or liability for any damages resulting from such improper use of sale.

This publication supersedes & replaces all information previously supplied. For additional information, please visit our website <http://www.21yangjie.com> , or consult your nearest Yangjie's sales office for further assistance.