

N-Channel Enhancement Mode Field Effect Transistor

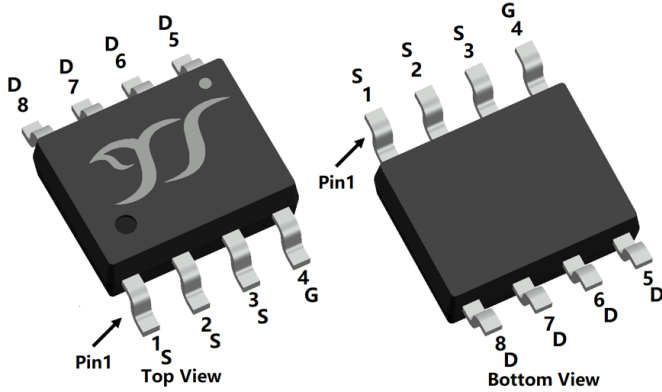

SOP-8

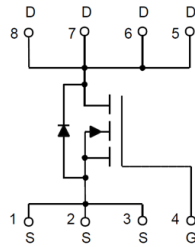

Product Summary

- V_{DS} 100V
- I_D 15A
- $R_{DS(ON)}$ (at $V_{GS}=10V$) < 9.5 mohm
- $R_{DS(ON)}$ (at $V_{GS}=4.5V$) < 12.5 mohm
- 100% EAS Tested

General Description

- Split Gate Trench MOSFET technology
- Excellent package for heat dissipation
- High density cell design for low $R_{DS(ON)}$
- Moisture Sensitivity Level 3
- Epoxy Meets UL 94 V-0 Flammability Rating
- Halogen Free

Applications

- DC/DC Primary Side Switch
- Telecom/Server
- Synchronous Rectification

■ Absolute Maximum Ratings ($I_A=25$ C unless otherwise noted)

Parameter	Symbol	Maximum	Unit
Drain-source Voltage	V_{DS}	100	V
Gate-source Voltage	V_{GS}	± 20	V
Drain Current	I_D	$T_A=25^\circ\text{C}$	15
		$T_A=100^\circ\text{C}$	9.5
Pulsed Drain Current ^A	I_{DM}	75	A
Avalanche Energy, Single Pulse(L=0.5mH)	E_{AS}	200	mJ
Total Power Dissipation ^B	P_D	3.8	W
Junction and Storage Temperature Range	T_J, T_{STG}	-55~+150	$^\circ\text{C}$

■ Thermal resistance

Parameter	Symbol	Typ	Max	Units
Thermal Resistance Junction-to-Ambient ^C	$R_{\theta JA}$	$t \leq 10S$	25	$^\circ\text{C/W}$
Thermal Resistance Junction-to-Ambient ^C		Steady-State	47	
Thermal Resistance Junction-to-Lead	$R_{\theta JL}$	Steady-State	13	

■ Ordering Information (Example)

PREFERRED P/N	PACKING CODE	Marking	MINIMUM PACKAGE(pcs)	INNER BOX QUANTITY(pcs)	OUTER CARTON QUANTITY(pcs)	DELIVERY MODE
YJS15G10A	F2	Q15G10A	4000	8000	64000	13" reel



YJS15G10A

■ Electrical Characteristics (T_J=25°C unless otherwise noted)

Parameter	Symbol	Conditions	Min	Typ	Max	Units
Static Parameter						
Drain-Source Breakdown Voltage	BV _{DSS}	V _{GS} = 0V, I _D =250μA	100			V
Zero Gate Voltage Drain Current	I _{DSS}	V _{DS} =100V, V _{GS} =0V, T _J =25°C			1	μA
Gate-Body Leakage Current	I _{GSS}	V _{GS} = ±20V, V _{DS} =0V			±100	nA
Gate Threshold Voltage	V _{GS(th)}	V _{DS} = V _{GS} , I _D =250μA	1.0	1.8	3.0	V
Static Drain-Source On-Resistance	R _{DS(on)}	V _{GS} =10V, I _D =10A		8.0	9.5	mΩ
	R _{DS(on)}	V _{GS} =4.5V, I _D =5A		9.7	12.5	mΩ
Diode Forward Voltage	V _{SD}	I _S =15A, V _{GS} =0V			1.3	V
Maximum Body-Diode Continuous Current	I _S				15	A
Gate resistance	R _G	f=1MHz, Open drain		0.68		Ω
Dynamic Parameters						
Input Capacitance	C _{iss}	V _{DS} =50V, V _{GS} =0V, f=1MHZ		2270		pF
Output Capacitance	C _{oss}			797		
Reverse Transfer Capacitance	C _{rss}			36		
Switching Parameters						
Total Gate Charge	Q _g	V _{GS} =10V, V _{DS} =50V, I _D =10A		32		nC
Gate-Source Charge	Q _{gs}			11.1		
Gate-Drain Charge	Q _{gd}			4.78		
Reverse Recovery Charge	Q _{rr}	I _F =10A, di/dt=100A/us		84		nC
Reverse Recovery Time	t _{rr}			51.5		ns
Turn-on Delay Time	t _{D(on)}	V _{GS} =10V, V _{DD} =50V, I _D =10A R _{GEN} =2.2Ω		51		ns
Turn-on Rise Time	t _r			14.4		
Turn-off Delay Time	t _{D(off)}			69.2		
Turn-off fall Time	t _f			20.6		

A. Repetitive rating; pulse width limited by max. junction temperature.

B. Pd is based on max. junction temperature, using ≤10s junction-ambient thermal resistance.

C. The value of R_{θJA} is measured with the device mounted on 1in² FR-4 board with 2oz. Copper, in a still air environment with T_A =25°C. The value in any given application depends on the user's specific board design.



YJS15G10A

■ Typical Performance Characteristics

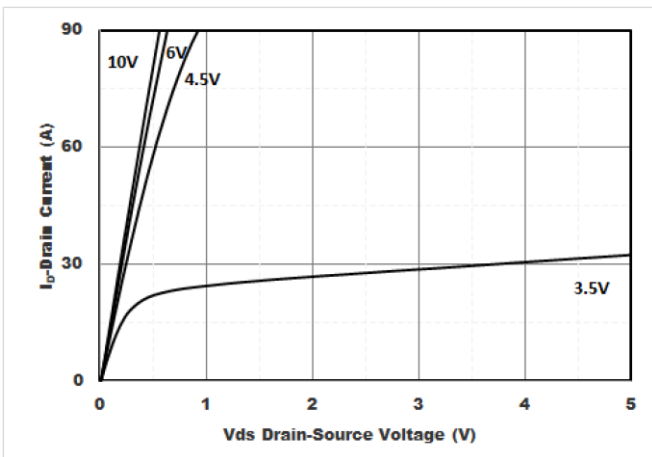

Figure1. Output Characteristics

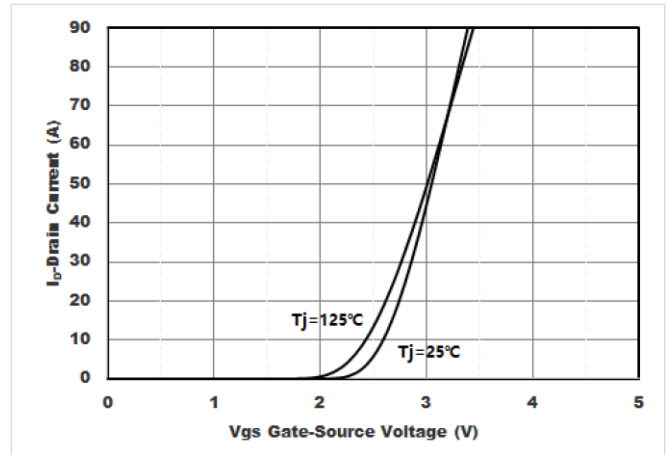

Figure2. Transfer Characteristics

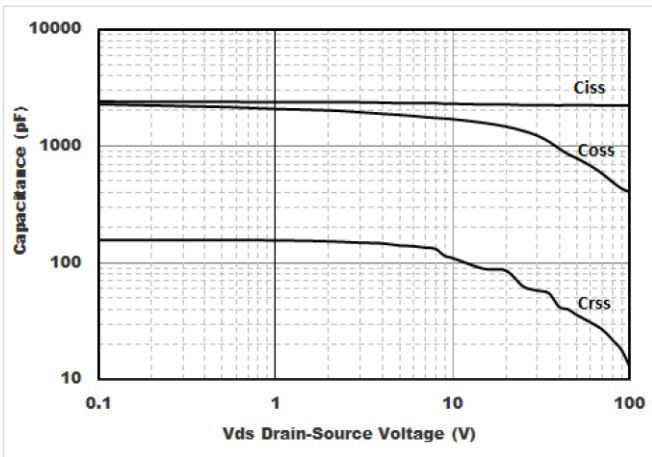

Figure3. Capacitance Characteristics

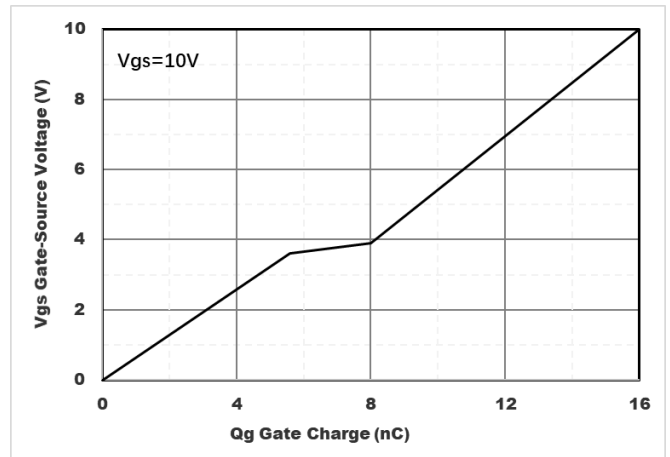

Figure4. Gate Charge

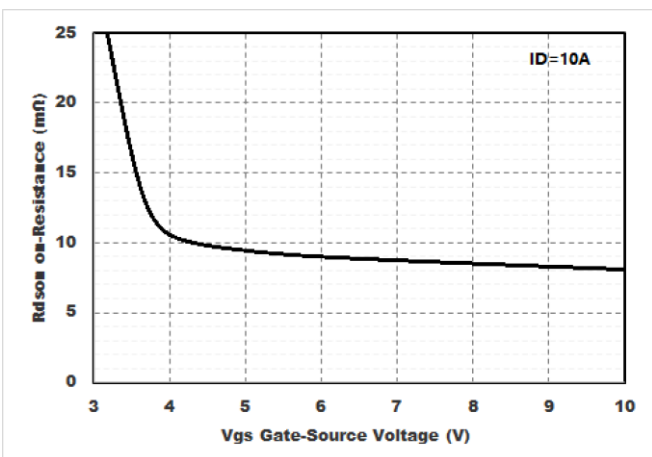

Figure5. Drain-Source on Resistance

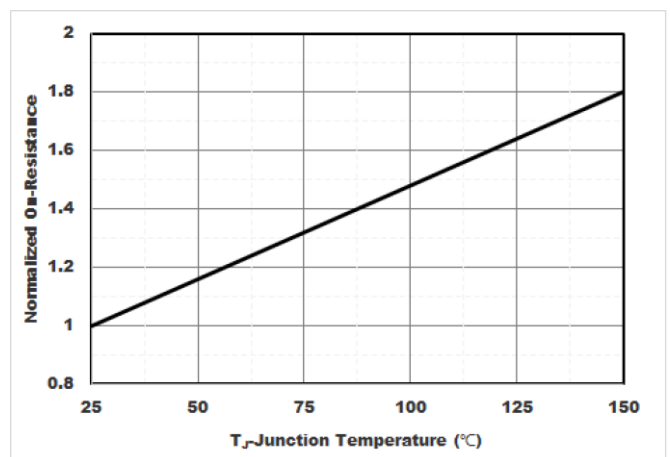

Figure6. Drain Current



YJS15G10A

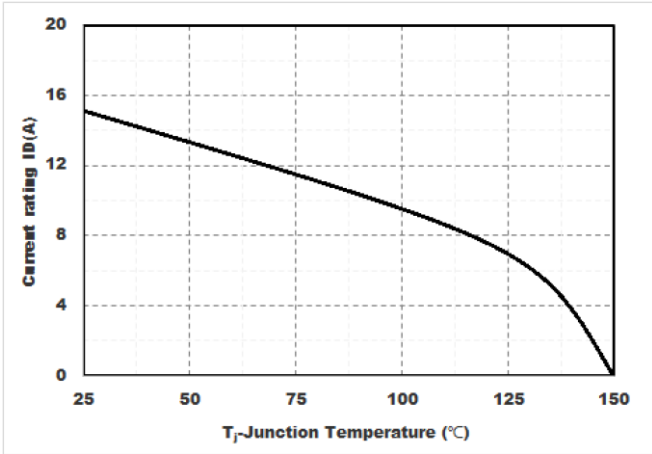

Figure7. Drain current

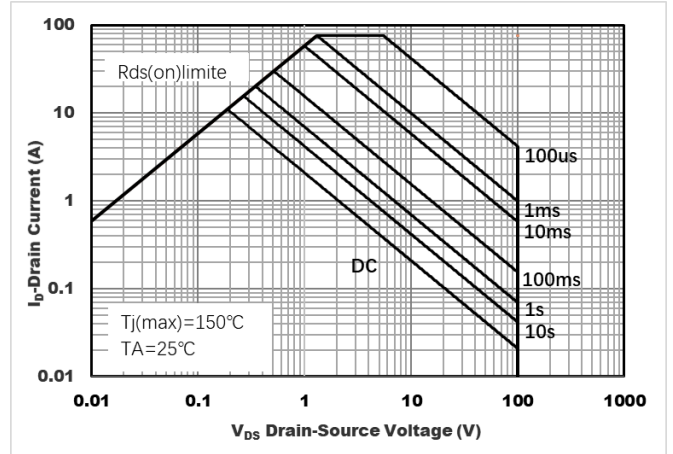

Figure8. Safe Operation Area

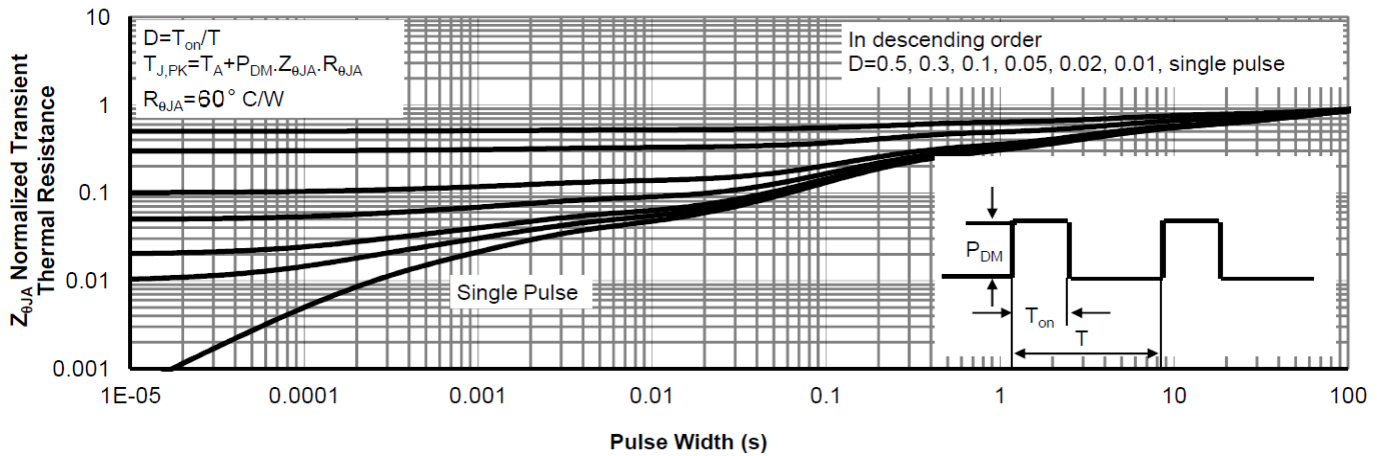
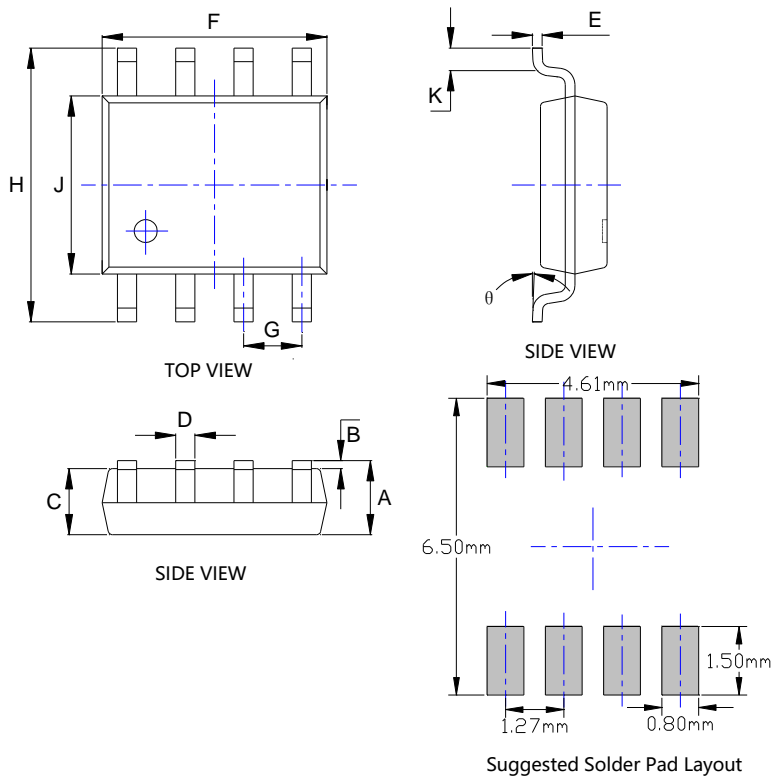

Figure9. Normalized Maximum Transient Thermal Impedance



YJS15G10A

■ SOP-8 Package information



SYMBOL	DIMENSIONS			
	INCHES		Millimeter	
	MIN.	MAX.	MIN.	MAX.
A	0.053	0.069	1.350	1.750
B	0.004	0.010	0.100	0.250
C	0.053	0.061	1.350	1.550
D	0.013	0.020	0.330	0.510
E	0.007	0.010	0.170	0.250
F	0.189	0.197	4.800	5.000
G	0.050BSC		1.270BSC	
H	0.228	0.244	5.800	6.200
J	0.150	0.157	3.800	4.000
K	0.016	0.050	0.400	1.270
θ	0°	8°	0°	8°

Note:

1. Controlling dimension: in millimeters.
2. General tolerance: $\pm 0.05\text{mm}$.
3. The pad layout is for reference purposes only.



YJS15G10A

Disclaimer

The information presented in this document is for reference only. Yangzhou Yangjie Electronic Technology Co., Ltd. reserves the right to make changes without notice for the specification of the products displayed herein to improve reliability, function or design or otherwise.

The product listed herein is designed to be used with ordinary electronic equipment or devices, and not designed to be used with equipment or devices which require high level of reliability and the malfunction of which would directly endanger human life (such as medical instruments, transportation equipment, aerospace machinery, nuclear-reactor controllers, fuel controllers and other safety devices), Yangjie or anyone on its behalf, assumes no responsibility or liability for any damages resulting from such improper use of sale.

This publication supersedes & replaces all information previously supplied. For additional information, please visit our website [http:// www.21yangjie.com](http://www.21yangjie.com) , or consult your nearest Yangjie's sales office for further assistance.