

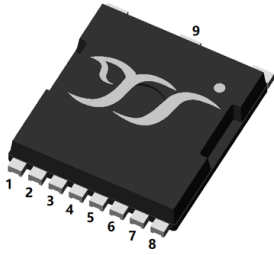

N-Channel Enhancement Mode Field Effect Transistor

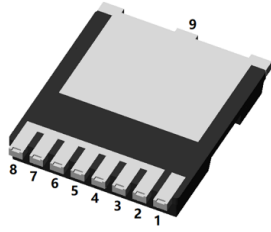

Top View



Bottom View

TOLL

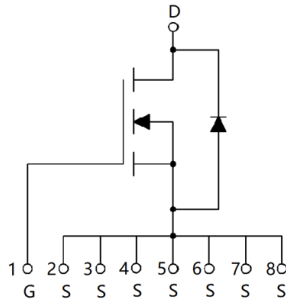

Product Summary

- V_{DS} 100V
- I_D 280A
- $R_{DS(ON)}$ (at $V_{GS}=10V$) $< 2.3m\Omega$
- $R_{DS(ON)}$ (at $V_{GS}=6V$) $< 3.5m\Omega$
- 100% EAS Tested
- 100% ∇V_{DS} Tested

General Description

- Double trench MOSFET technology
- Excellent package for heat dissipation
- High density cell design for low $R_{DS(ON)}$
- Moisture Sensitivity Level 1
- Epoxy Meets UL 94 V-0 Flammability Rating
- Halogen Free

Applications

- High Power switching application
- BMS

■ Absolute Maximum Ratings ($T_A=25^\circ C$ unless otherwise noted)

Parameter		Symbol	Limit	Unit
Drain-source Voltage		V_{DS}	100	V
Gate-source Voltage		V_{GS}	± 20	V
Drain Current	$T_A=25^\circ C$	I_D	28	A
	$T_A=100^\circ C$		17.7	
	$T_C=25^\circ C$		280	
	$T_C=100^\circ C$		177	
Pulsed Drain Current ^A		I_{DM}	900	A
Avalanche energy ^B		EAS	2250	mJ
Total Power Dissipation ^C	$T_A=25^\circ C$	P_D	3.5	W
	$T_A=100^\circ C$		1.4	
	$T_C=25^\circ C$		250	
	$T_C=100^\circ C$		100	
Junction and Storage Temperature Range		T_J, T_{STG}	-55~+150	$^\circ C$

■ Thermal resistance

Parameter		Symbol	Typ	Max	Units
Thermal Resistance Junction-to-Ambient ^D	Steady-State	$R_{\theta JA}$	30	35	$^\circ C/W$
Thermal Resistance Junction-to-Case	Steady-State	$R_{\theta JC}$	0.4	0.5	

■ Ordering Information (Example)

PREFERRED P/N	PACKING CODE	Marking	MINIMUM PACKAGE(pcs)	INNER BOX QUANTITY(pcs)	OUTER CARTON QUANTITY(pcs)	DELIVERY MODE
YJT280G10HJ	F1	YJT280G10HJ	2000	4000	20000	13" reel



YJT280G10HJ

RECOMMEND
YJT300G10H
FOR NEW DESIGN

■ Electrical Characteristics (T_J=25°C unless otherwise noted)

Parameter	Symbol	Conditions	Min	Typ	Max	Units
Static Parameter						
Drain-Source Breakdown Voltage	BV _{DSS}	V _{GS} =0V, I _D =250μA	100	-	-	V
Zero Gate Voltage Drain Current	I _{DSS}	V _{DS} =100V, V _{GS} =0V	-	-	1	μA
		V _{DS} =100V, V _{GS} =0V, T _J =150°C	-	-	100	
Gate-Body Leakage Current	I _{GSS}	V _{GS} =±20V, V _{DS} =0V	-	-	±100	nA
Gate Threshold Voltage	V _{GS(th)}	V _{DS} =V _{GS} , I _D =250μA	2	3	4	V
Static Drain-Source On-Resistance	R _{DS(on)}	V _{GS} =10V, I _D =140A	-	1.7	2.3	mΩ
		V _{GS} =10V, I _D =50A	-	1.7	2.3	
		V _{GS} =6V, I _D =50A	-	2.4	3.5	
Diode Forward Voltage	V _{SD}	I _S =140A, V _{GS} =0V	-	0.9	1.2	V
Gate resistance	R _G	f=1MHz, Open drain	-	1.3	-	Ω
Maximum Body-Diode Continuous Current	I _S		-	-	280	A
Dynamic Parameters						
Input Capacitance	C _{iss}	V _{DS} =50V, V _{GS} =0V, f=1MHz	-	15200	-	pF
Output Capacitance	C _{oss}		-	1850	-	
Reverse Transfer Capacitance	C _{rss}		-	50	-	
Switching Parameters						
Total Gate Charge	Q _g	V _{GS} =10V, V _{DS} =50V, I _D =140A	-	225	-	nC
Gate-Source Charge	Q _{gs}		-	80	-	
Gate-Drain Charge	Q _{gd}		-	40	-	
Reverse Recovery Charge	Q _{rr}	I _F =140A, di/dt=100A/us	-	280	-	nC
Reverse Recovery Time	t _{rr}		-	100	-	ns
Turn-on Delay Time	t _{D(on)}	V _{GS} =10V, V _{DD} =50V, I _D =140A R _{GEN} =1.6Ω	-	35	-	ns
Turn-on Rise Time	t _r		-	25	-	
Turn-off Delay Time	t _{D(off)}		-	80	-	
Turn-off fall Time	t _f		-	30	-	

- A. Repetitive rating; pulse width limited by max. junction temperature.
 B. T_J=25°C, V_{DD}=50V, V_G=10V, R_G=25Ω, L=5mH, I_{AS}=30A.
 C. P_q is based on max. junction temperature, using junction-case thermal resistance.
 D. The value of R_{θJA} is measured with the device mounted on 1 in² FR-4 board with 2oz. Copper, in the still air environment with T_A=25°C. The maximum allowed junction temperature of 150°C. The value in any given application depends on the user's specific board design.

Typical Electrical and Thermal Characteristics Diagrams

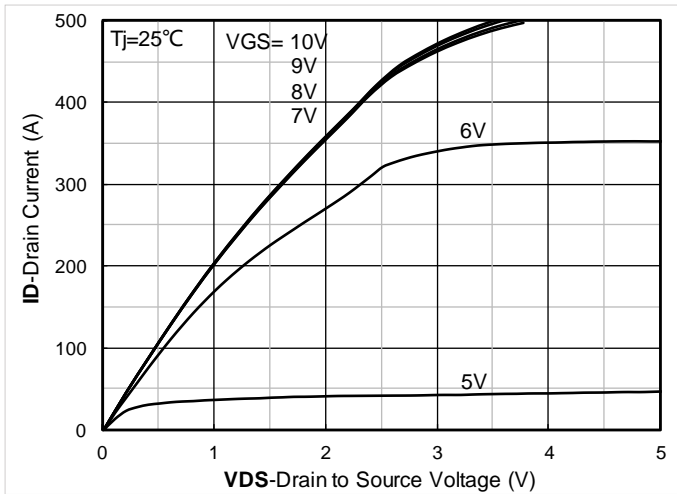

Figure 1. Output Characteristics

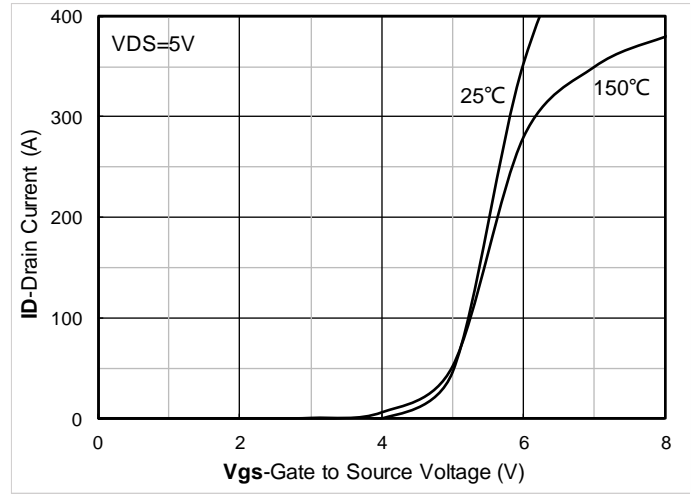

Figure 2. Transfer Characteristics

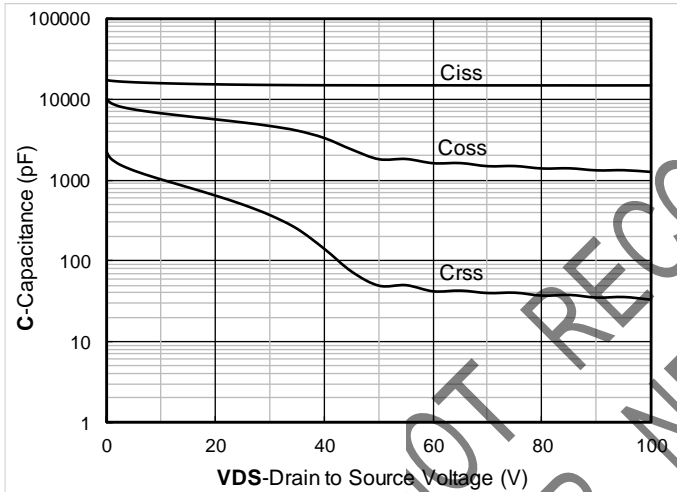

Figure 3. Capacitance Characteristics

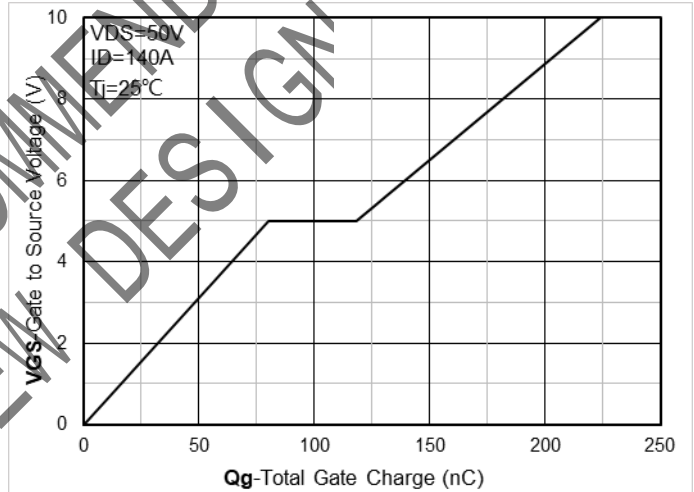

Figure 4. Gate Charge

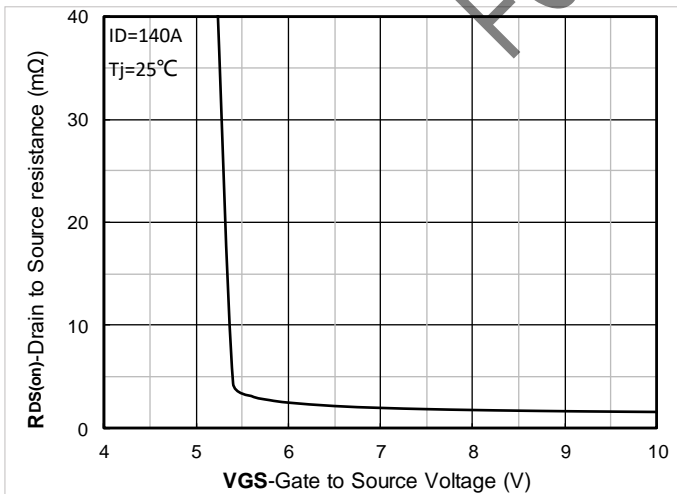

Figure 5. On-Resistance vs Gate to Source Voltage

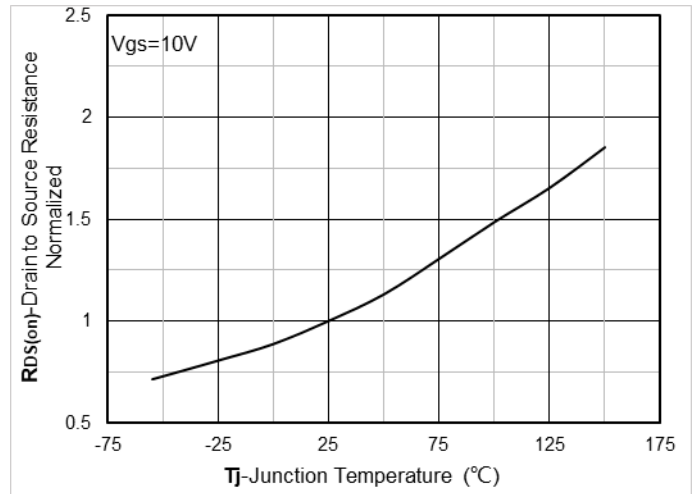

Figure 6. Normalized On-Resistance

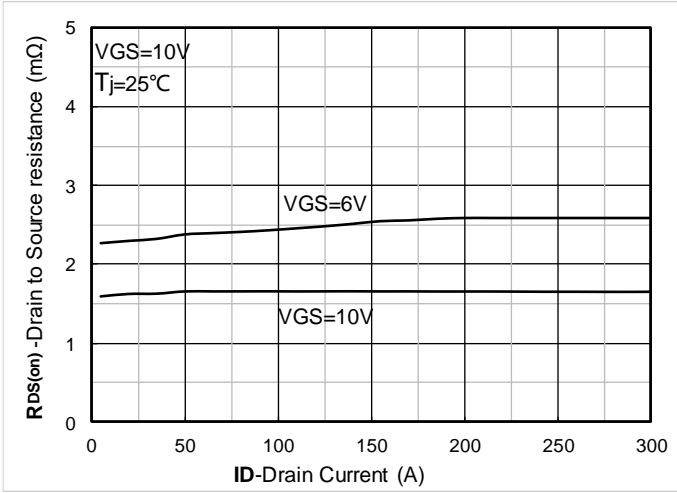

Figure 7. RDS(on) VS Drain Current

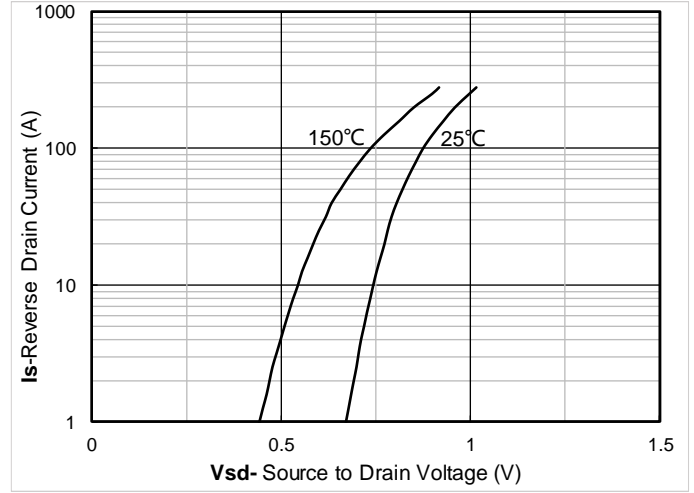

Figure 8. Forward characteristics of reverse diode

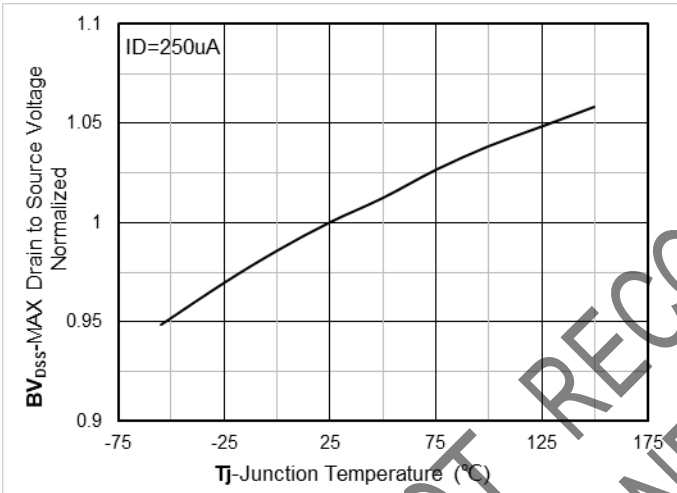

Figure 9. Normalized breakdown voltage

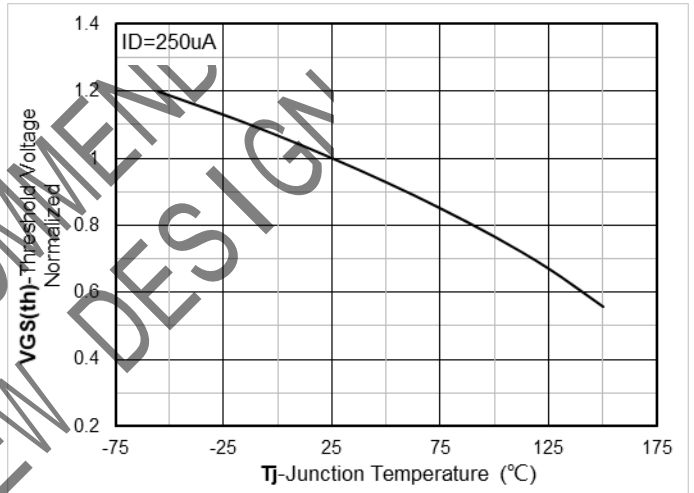

Figure 10. Normalized Threshold voltage

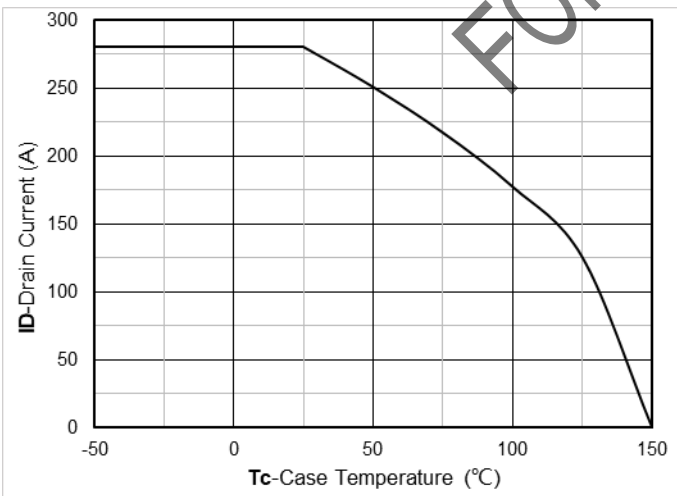

Figure 11. Current dissipation

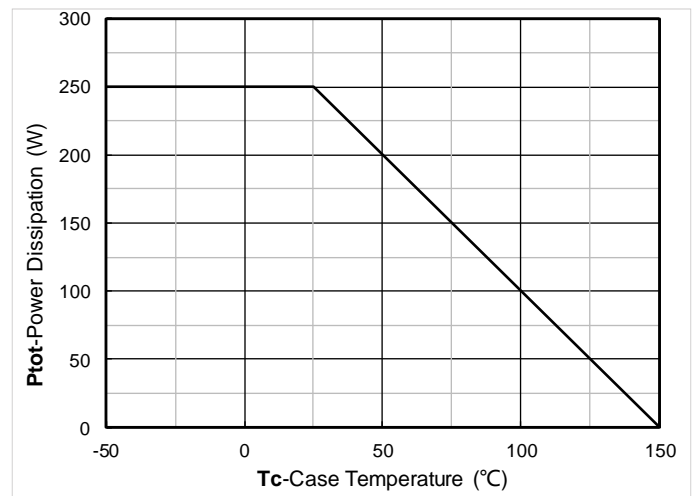

Figure 12. Power dissipation

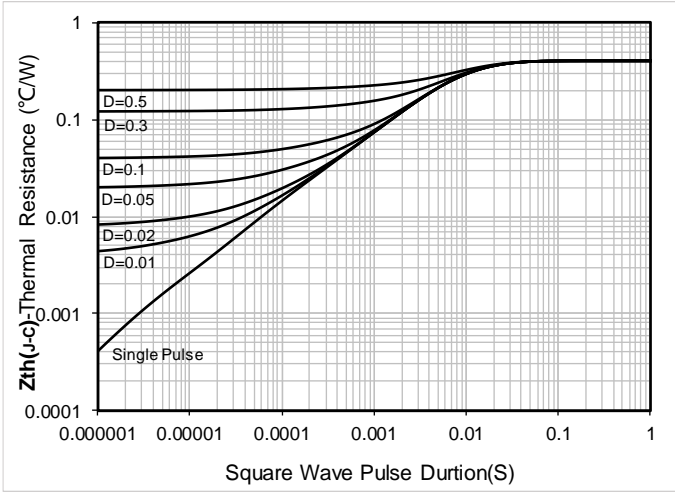

Figure 13. Maximum Transient Thermal Impedance

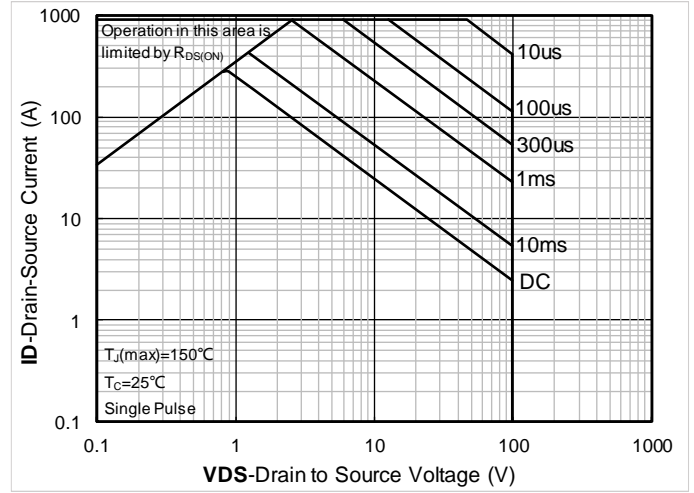

Figure 14. Safe Operation Area

■ Test Circuits & Waveforms

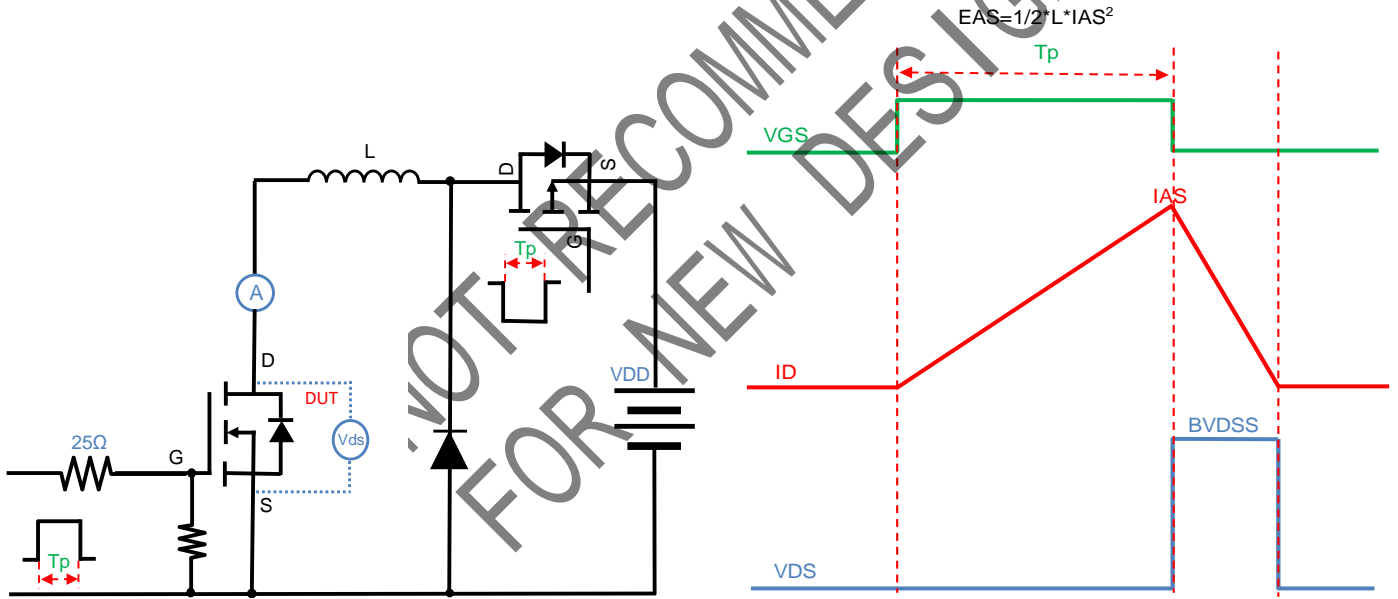

Figure A. Unclamped Inductive Switching (UIS) Test Circuit & Waveform

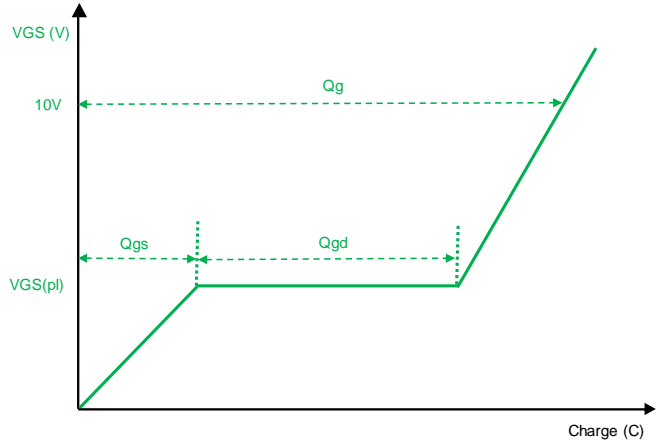
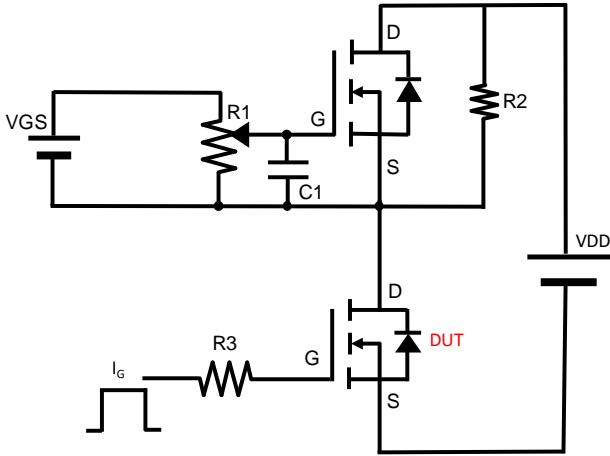

Figure B. Gate Charge Test Circuit & Waveform

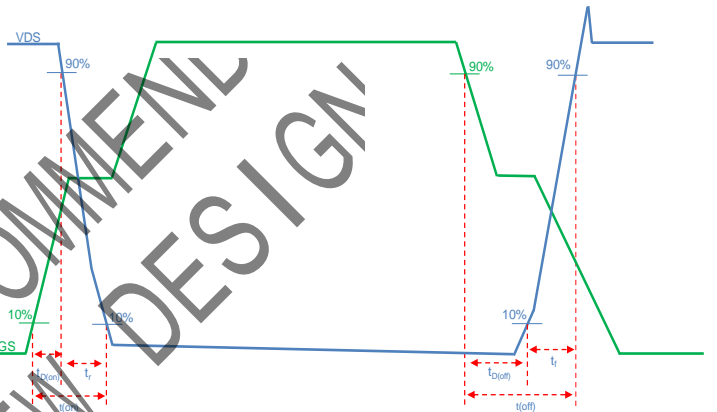
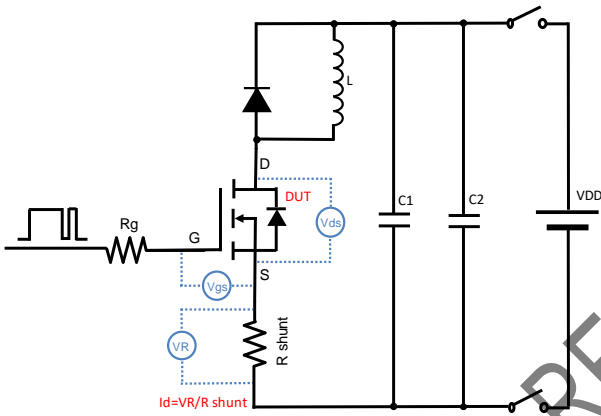

Figure C. Resistive Switching Test Circuit & Waveform

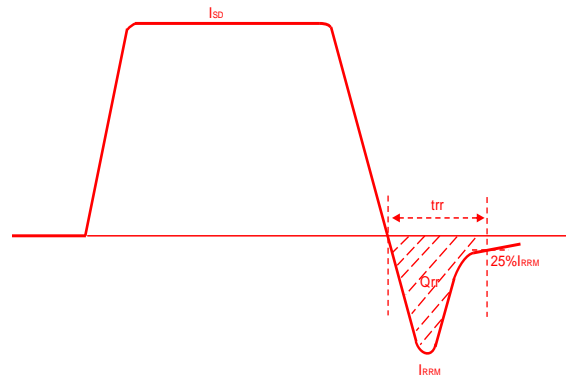
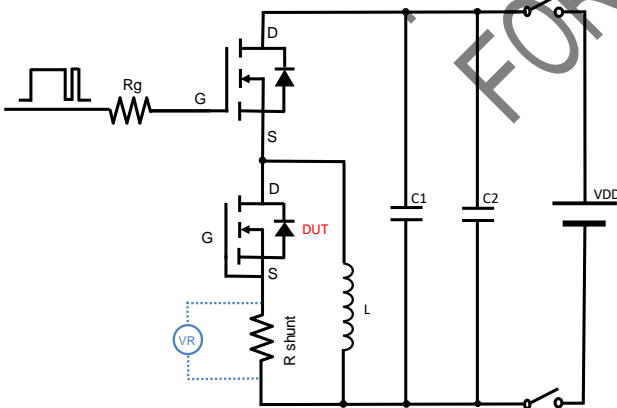

Figure D. Diode Recovery Test Circuit & Waveform



YJT280G10HJ

RECOMMEND
YJT300G10H
FOR NEW DESIGN

■TOLL Package information TYPE A:

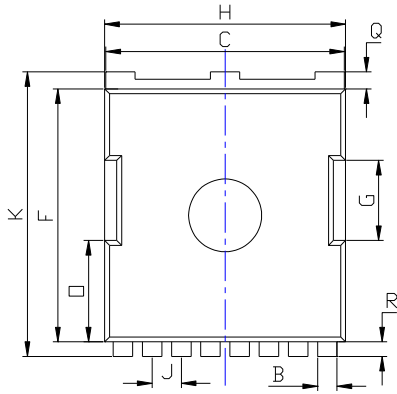

TOP VIEW

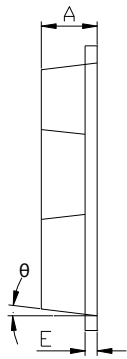

SIDE VIEW

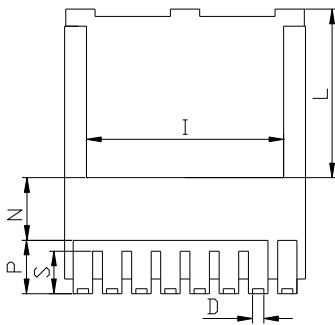

BOTTOM VIEW

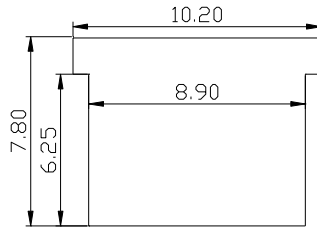

SUGGESTED SOLDER PAD LAYOUT

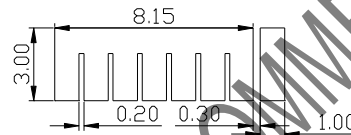

SYMBOL	DIMENSIONS			
	INCHES		Millimeter	
	MIN.	MAX.	MIN.	MAX.
A	0.087	0.094	2.20	2.40
B	0.028	0.035	0.70	0.90
C	0.382	0.390	9.70	9.90
D	0.017	0.020	0.42	0.50
E	0.016	0.024	0.40	0.60
F	0.405	0.417	10.28	10.58
G	0.122	0.138	3.10	3.50
H	0.382	0.398	9.70	10.10
I	0.311	0.327	7.90	8.30
J	0.047BSC.		1.20BSC.	
K	0.452	0.468	11.48	11.88
L	0.266	0.281	6.75	7.15
N	0.118	0.130	3.00	3.30
Q	0.157	0.172	3.98	4.38
P	0.055	0.071	1.40	1.80
R	0.024	0.031	0.60	0.80
S	0.039	0.051	1.00	1.30
θ	4°	10°	4°	10°

NOTE:
1. PACKAGE BODY SIZES EXCLUDE MOLD FLASH AND GATE BURRS.
2. TOLERANCE 0.1mm UNLESS OTHERWISE SPECIFIED.

TYPE B:

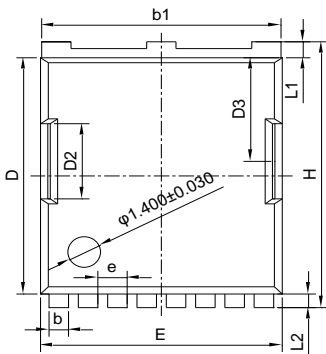

TOP VIEW



SIDE VIEW

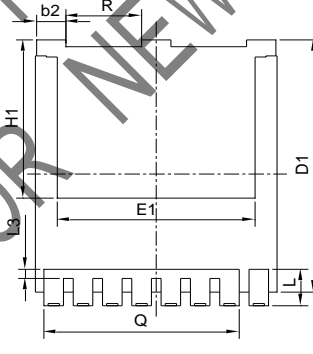

BOTTOM VIEW

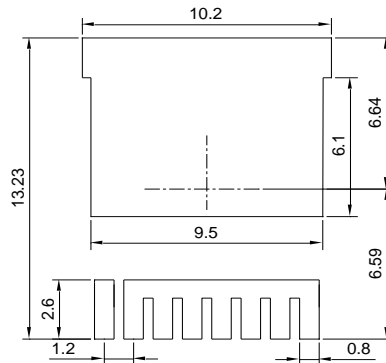

SUGGESTED SOLDER PAD LAYOUT
TOP VIEW

SYMBOL	MILLIMETER		
	MIN	NOM	MAX
A	2.2	2.3	2.4
A1	1.7	1.8	1.9
b	0.7	0.8	0.9
b1	9.7	9.8	9.9
b2	1.1	1.2	1.3
c	0.4	0.5	0.6
D	10.28	10.38	10.48
D1	10.98	11.08	11.18
D2	3.2	3.3	3.4
D3	4.45	4.55	4.65
E	9.8	9.9	10
E1	8	8.1	8.2
e	1.2 BSC		
H	11.58	11.68	11.78
H1	6.95 BSC		
i	0.1 REF		
j	0.46 REF		
L	1.5	1.6	1.7
L1	0.6	0.7	0.8
L2	0.5	0.6	0.7
L3	0.3	0.4	0.5
Q	8 REF		
R	3.0	3.1	3.2

Note:
1. Controlling dimension: in millimeters.
2. General tolerance: ±0.03mm.
3. The pad layout is for reference purposes only.

UNIT: mm



Disclaimer

The information presented in this document is for reference only. Yangzhou Yangjie Electronic Technology Co., Ltd. reserves the right to make changes without notice for the specification of the products displayed herein to improve reliability, function or design or otherwise.

The product listed herein is designed to be used with ordinary electronic equipment or devices, and not designed to be used with equipment or devices which require high level of reliability and the malfunction of which would directly endanger human life (such as medical instruments, transportation equipment, aerospace machinery, nuclear-reactor controllers, fuel controllers and other safety devices), Yangjie or anyone on its behalf, assumes no responsibility or liability for any damages resulting from such improper use of sale.

This publication supersedes & replaces all information previously supplied. For additional information, please visit our website <http://www.21yangjie.com>, or consult your nearest Yangjie's sales office for further assistance.

NOT RECOMMENDED
FOR NEW DESIGN