

NPN General Purpose Amplifier



Features

- Epoxy meets UL-94 V-0 flammability rating
- Halogen free available upon request by adding suffix "HF"
- Moisture sensitivity level 1
- Low collector-emitter saturation voltage

Mechanical Data

- **Package:** SOT-89
- Molding compound meets UL 94 V-0 flammability rating, RoHS-compliant, halogen-free
- **Terminals:** Tin plated leads, solderable per J-STD-002 and JESD22-B102
- **Marking:** DAR

■ Maximum Ratings (Ta=25°C unless otherwise noted)

Item	Symbol	Unit	Conditions	Value
Minimum Collector-Emitter Voltage	V_{CEO}	V	$I_C=1mA, I_B=0$	32
Minimum Collector-Base Voltage	V_{CBO}	V	$I_C=50\mu A, I_E=0$	40
Minimum Emitter-Base Voltage	V_{EBO}	V	$I_E=50\mu A, I_C=0$	5
Collector Current	I_C	A		1
Collector Power Dissipation	P_C	mW		500
Thermal Resistance From Junction To Ambient	$R_{\theta JA}$	°C/W		250
Operation Junction Temperature	T_j	°C		-55 to +150
Storage Temperature	T_{stg}	°C		-55 to +150



■ Electrical Characteristics (Ta=25°C unless otherwise noted)

Item	Symbol	Unit	Conditions	Min	TYP	Max
Collector-Emitter Voltage	V_{CEO}	V	$I_C=1mA, I_B=0$	32		
Collector-Base Voltage	V_{CBO}	V	$I_C=50\mu A, I_E=0$	40		
Emitter-Base Voltage	V_{EBO}	V	$I_E=50\mu A, I_C=0$	5		
Collector-Base cut-off current	I_{CBO}	μA	$V_{CB}=20V$			0.5
Emitter-Base cut-off current	I_{EBO}	μA	$V_{EB}=4V$			0.5
DC Current Gain	h_{FE}		$V_{CE}=3V, I_C=100mA$	180		390
Collector-Emitter Saturation Voltage	$V_{CE(sat)}$	V	$I_C=500mA, I_B=50mA$			0.4
Transition Frequency	f_T	MHz	$I_C=50mA, V_{CE}=5V, f=100MHz$		150	
Output Capacitance	Cob	pF	$V_{CB}=10V, I_E=0, f=1MHz$		15	

■ Ordering Information (Example)

PREFERED P/N	PACKING CODE	UNIT WEIGHT(g)	MINIMUM PACKAGE(pcs)	INNER BOX QUANTITY(pcs)	OUTER CARTON QUANTITY(pcs)	DELIVERY MODE
2SD1664-R	F2	Approximate 0.055	1000	8000	32000	7" reel

■ Characteristics (Typical)

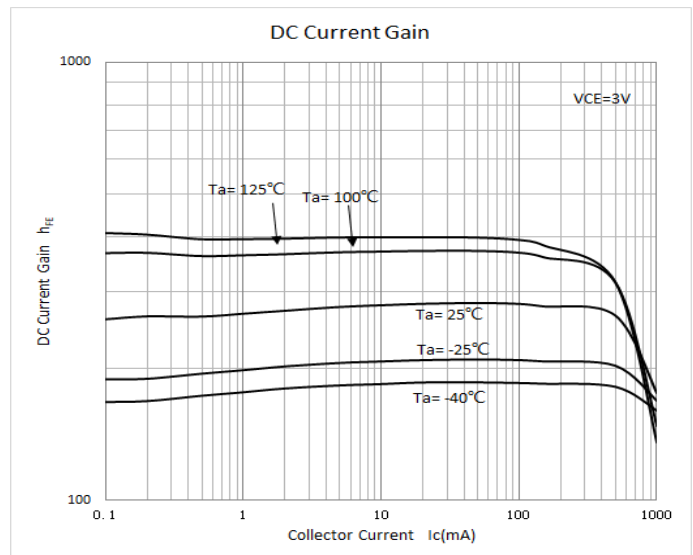
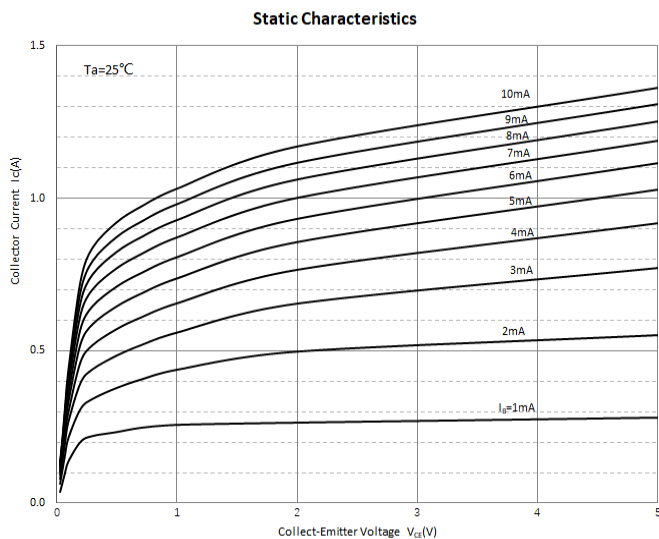

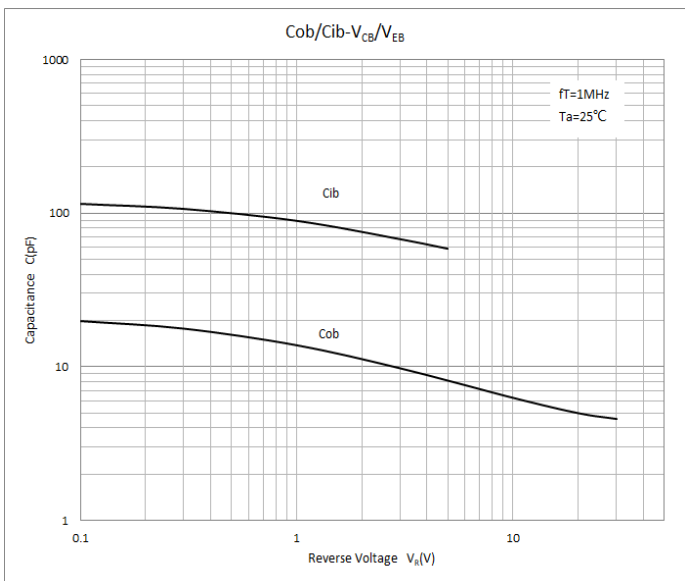
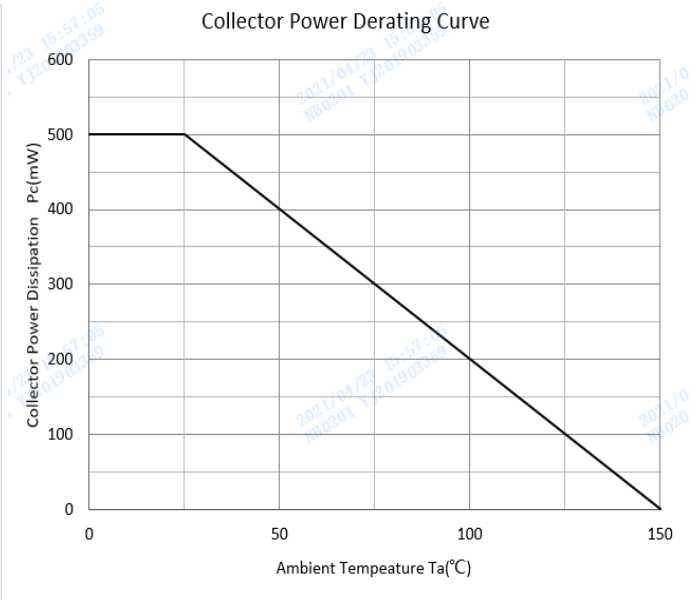
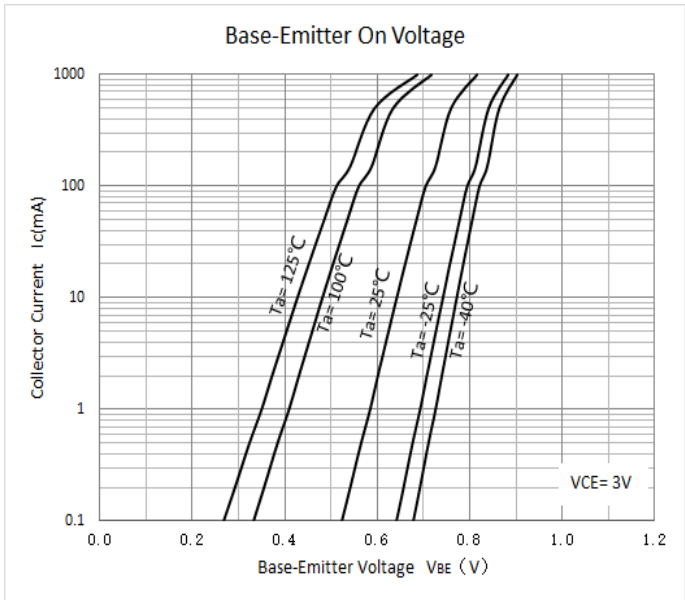
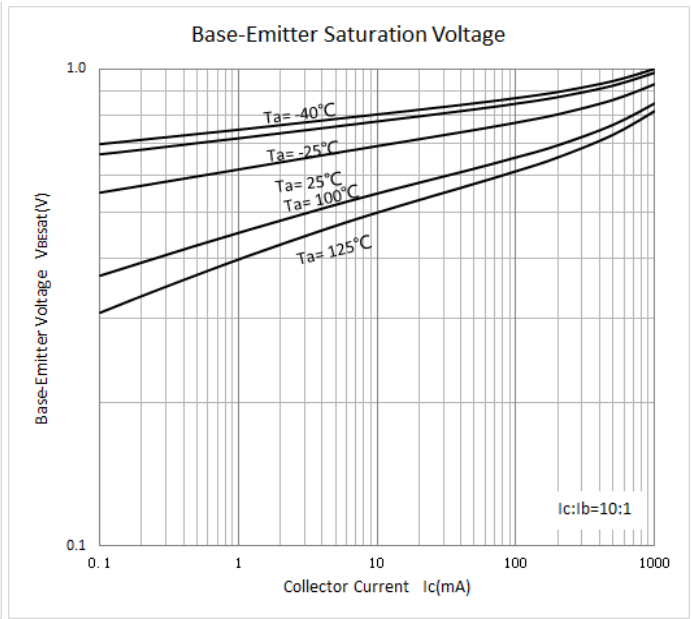
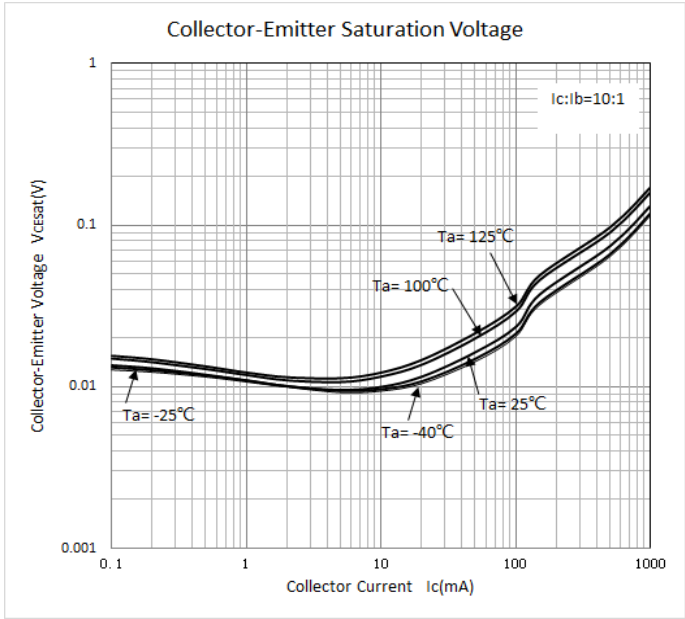

■SOT-89 Package Outline Dimensions

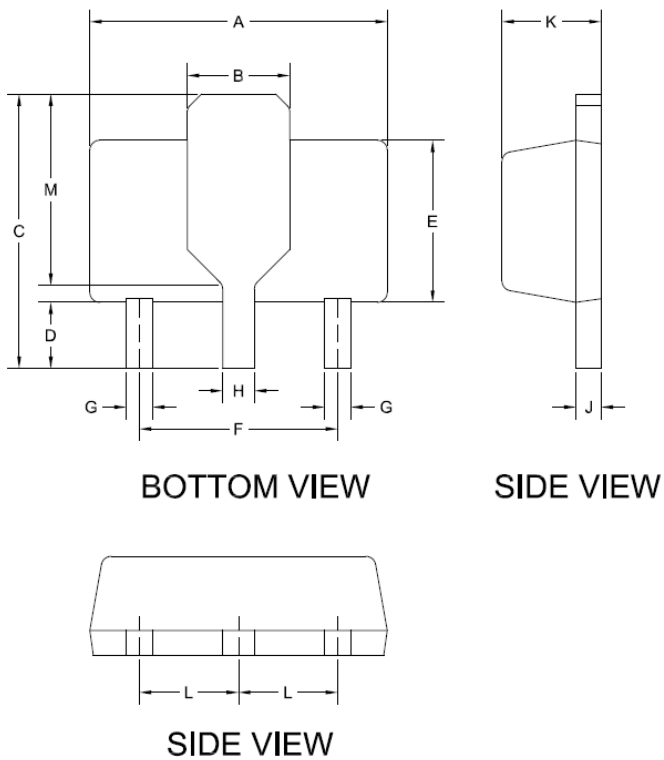

DIM	DIMENSIONS			
	INCHES		MM	
	MIN.	MAX.	MIN.	MAX.
A	0.173	0.181	4.400	4.600
B	0.061 TYP.		1.550 TYP.	
C	0.155	0.167	3.940	4.250
D	0.031	0.047	0.800	1.200
E	0.094	0.102	2.400	2.600
F	0.118 TYP.		3.00 TYP.	
G	0.014	0.019	0.360	0.480
H	0.017	0.022	0.440	0.560
J	0.014	0.017	0.350	0.440
K	0.055	0.063	1.400	1.600
L	0.059 TYP.		1.500 TYP.	
M	0.108 TYP.		2.750 TYP.	

■SOT-89 Suggested Pad Layout

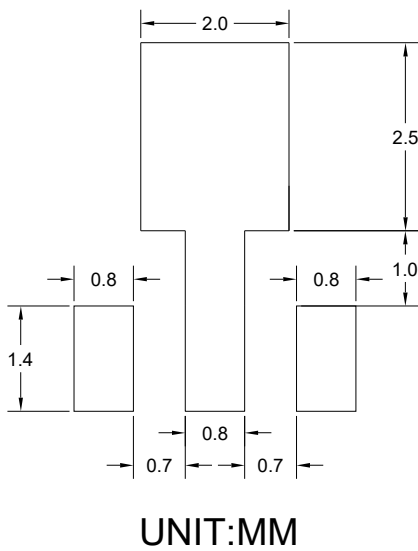



Disclaimer

The information presented in this document is for reference only. Yangzhou Yangjie Electronic Technology Co., Ltd. reserves the right to make changes without notice for the specification of the products displayed herein to improve reliability, function or design or otherwise.

The product listed herein is designed to be used with ordinary electronic equipment or devices, and not designed to be used with equipment or devices which require high level of reliability and the malfunction of which would directly endanger human life (such as medical instruments, transportation equipment, aerospace machinery, nuclear-reactor controllers, fuel controllers and other safety devices), Yangjie or anyone on its behalf, assumes no responsibility or liability for any damages resulting from such improper use of sale.

This publication supersedes & replaces all information previously supplied. For additional information, please visit our website [http:// www.21yangjie.com](http://www.21yangjie.com) , or consult your nearest Yangjie's sales office for further assistance.