

## Ultra-Fast Recovery Diodes 30A FRED

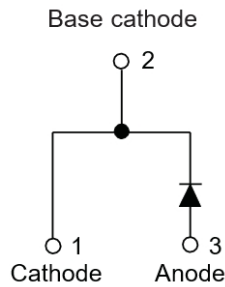

### Features

- Adopt FRED chip
- Low forward Voltage drop
- Fast reverse recovery time
- High frequency operation
- High purity, high temperature epoxy encapsulation for enhanced mechanical strength and moisture resistance
- Guard ring for enhanced ruggedness and long term reliability

### Typical Applications

- Typical applications are in switching power supplies, converters, freewheeling diodes, and reverse battery protection.

### Mechanical Data

- **Package:** TO-247AC  
Molding compound meets UL 94 V-0 flammability rating, RoHS-compliant
- **Terminals:** Tin plated leads, solderable per J-STD-002 and JESD22-B102
- **Polarity:** As marked

### ■ Maximum Ratings (T<sub>j</sub>=25°C Unless otherwise specified)

PARAMETER	SYMBOL	UNIT	MURU3060P
Device marking code			MURU3060P
Repetitive Peak Reverse Voltage	VRRM	V	600
Average Rectified Output Current @60Hz sine wave, R-load, T <sub>c</sub> (FIG.1)	I <sub>O</sub>	A	30
Surge(Non-repetitive)Forward Current @60Hz half sine-wave, 1 cycle, T <sub>j</sub> =25°C	I <sub>FSM</sub>	A	460
Current Squared Time @1ms≤t≤8.3ms T <sub>j</sub> =25°C,	I <sup>2</sup> t	A <sup>2</sup> s	878
Storage Temperature	T <sub>stg</sub>	°C	-55 ~ +175
Junction Temperature	T <sub>j</sub>	°C	-55 ~ +175
Typical Junction capacitance @4V,1MHz	C <sub>j</sub>	pF	195



# MURU3060P

## ■Electrical Characteristics

PARAMETER	SYMBOL	UNIT	TEST CONDITIONS	Min	Typ	Max	
Instantaneous forward voltage drop per diode	$V_{FM}$	V	$I_{FM}=30.0A @T_J=25^{\circ}C$	-	1.20	1.55	
			$I_{FM}=30.0A @T_J=125^{\circ}C$	-	1.08	1.35	
DC reverse current at rated DC blocking voltage per diode	$I_{RRM1}$	uA	$V_{RM}=V_{RRM}$ $T_J=25^{\circ}C$	-	-	5.0	
	$I_{RRM2}$		$V_{RM}=V_{RRM}$ $T_J=125^{\circ}C$	-	-	200	
Reverse Recovery Time	$T_{rr}$	ns	$I_F=0.5A$ $I_{RM}=1A$ $I_{RR}=0.25A$ $T_J=25^{\circ}C$	-	55	70	
			$T_J=25^{\circ}C$	-	93	-	
			$T_J=125^{\circ}C$	-	157	-	
Peak recovery current	$I_{RRM}$	A	$T_J=25^{\circ}C$	$I_F=30A$ $di/dt=-200A/us$ $V_{RM}=400V$	-	8.86	-
			$T_J=125^{\circ}C$		-	17.66	-
Reverse recovery charge	$Q_{rr}$	nC	$T_J=25^{\circ}C$	-	412	-	
			$T_J=125^{\circ}C$	-	1489	-	

## ■Thermal Characteristics ( $T_J=25^{\circ}C$ Unless otherwise specified )

PARAMETER		SYMBOL	UNIT	MURU3060P
Thermal Resistance	Between junction and case	$R_{\theta J-C}$	$^{\circ}C/W$	1.0
	Between junction and Air	$R_{\theta J-A}$	$^{\circ}C/W$	40

## ■ Characteristics(Typical)

FIG1:  $I_o$ - $T_c$  Curve

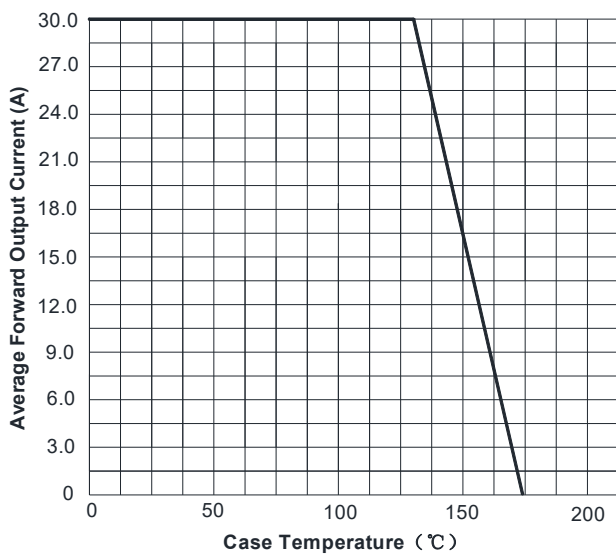

FIG2: Surge Forward Current Capability

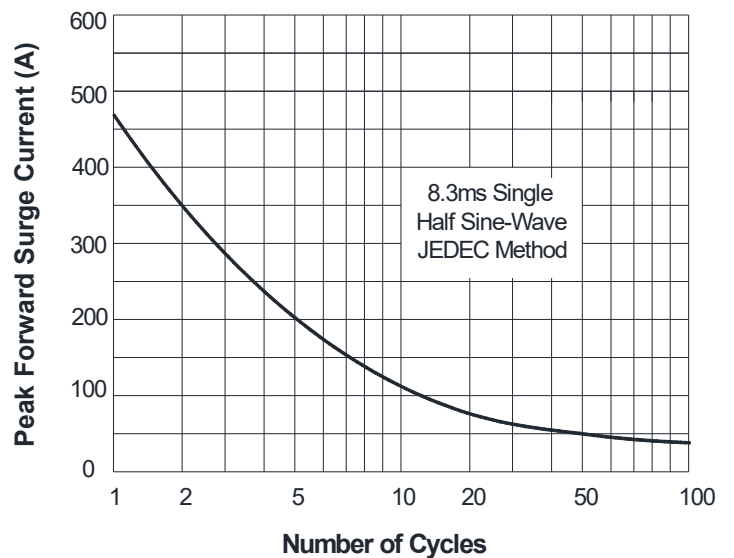



FIG3: Forward Voltage

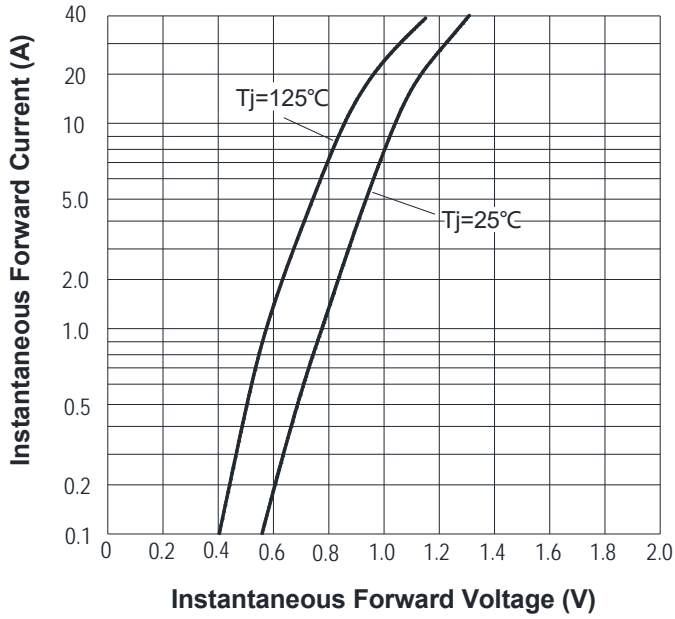

FIG.4: Instantaneous Reverse Characteristics

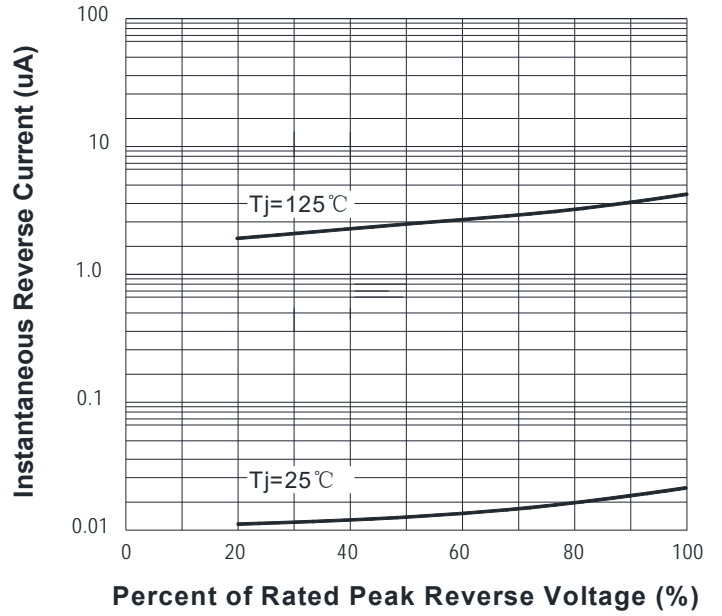
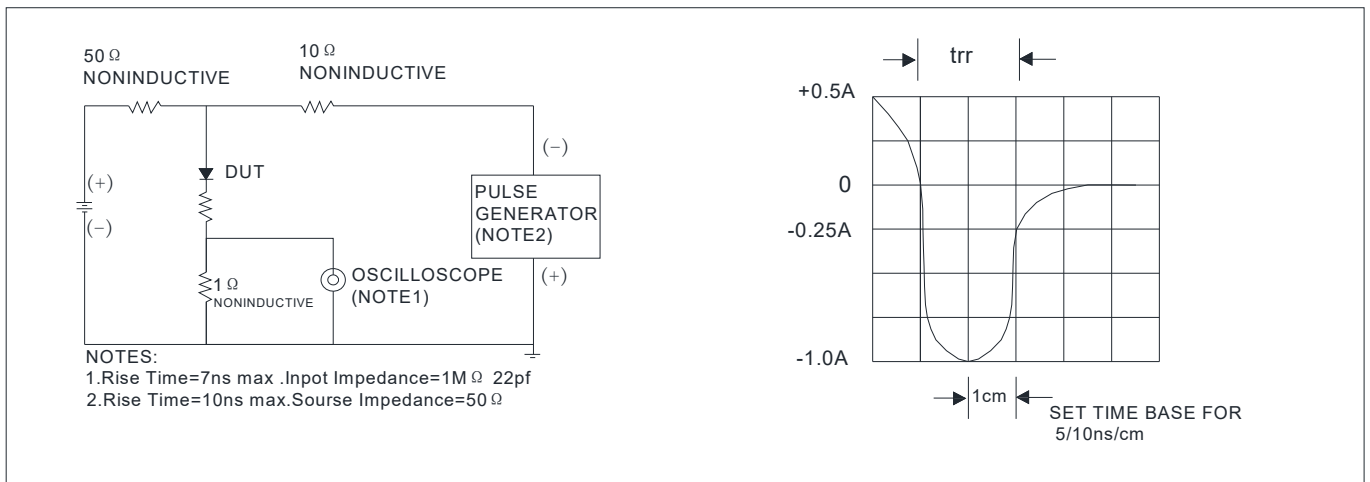

FIG.5: Diagram of circuit and Testing wave form of reverse recovery time





# MURU3060P

## ■ Outline Dimensions

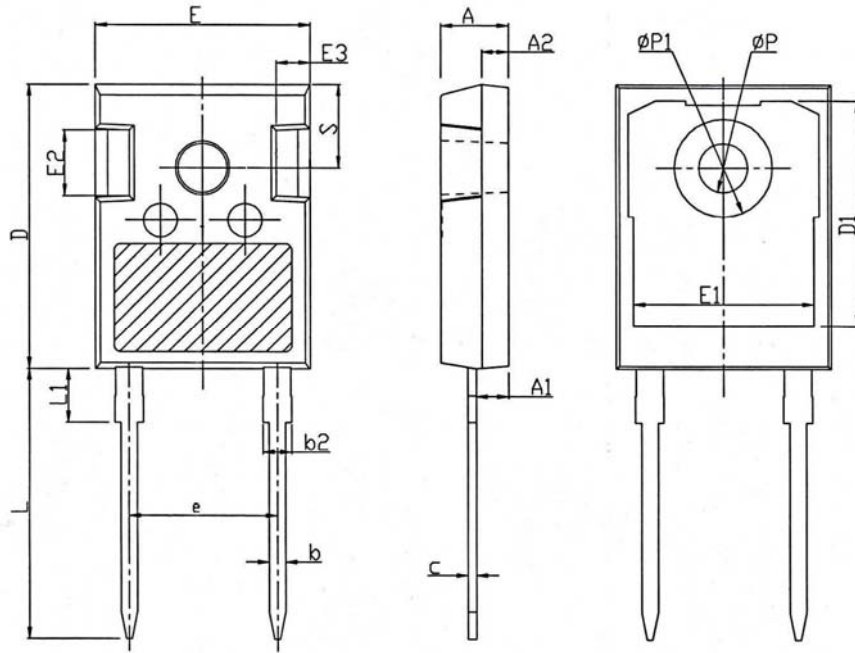

TO-247AC		
Dim	Min	Max
A	4.80	5.20
A1	2.21	2.61
A2	1.85	2.15
b	1.11	1.36
b2	1.91	2.21
c	0.51	0.75
D	20.70	21.30
D1	16.25	16.85
E	15.50	16.10
E1	13.00	13.60
E2	4.80	5.20
E3	2.30	2.70
e	10.88BSC	
L	19.62	20.22
L1	-	4.30
φP	3.40	3.80
φP1	-	7.30
S	6.15BSC	



## MURU3060P

---

### Disclaimer

The information presented in this document is for reference only. Yangzhou Yangjie Electronic Technology Co., Ltd. reserves the right to make changes without notice for the specification of the products displayed herein to improve reliability, function or design or otherwise.

The product listed herein is designed to be used with ordinary electronic equipment or devices, and not designed to be used with equipment or devices which require high level of reliability and the malfunction of which would directly endanger human life (such as medical instruments, transportation equipment, aerospace machinery, nuclear-reactor controllers, fuel controllers and other safety devices), Yangjie or anyone on its behalf, assumes no responsibility or liability for any damages resulting from such improper use of sale.

This publication supersedes & replaces all information previously supplied. For additional information, please visit our website [http:// www.21yangjie.com](http://www.21yangjie.com) , or consult your nearest Yangjie's sales office for further assistance.